



# 8

## PUSH-IN FITTINGS

CD PNEUMATICS

 		
<b>470</b> One Touch 20 Bar Fittings	<b>475</b> One Touch Fittings Metric	<b>490</b> One Touch Push-In Fittings Kits

CD PNEUMATICS

		
<b>491</b> One Touch Fittings Imperial	<b>493</b> Compact One Touch Fittings – Metric	<b>496</b> Stop Fittings Metric

CD PNEUMATICS

	
<b>497</b> Speed Controllers Meter-Out	<b>501</b> Speed Controllers with Pilot Check Valves

PARKAIR

<b>502</b> Brass Nickel Plated Push-In Fittings

AIGNEP

		
<b>504</b> Push-In Fittings Plated Brass	<b>509</b> High Pressure Push-In Fittings 58000 Series	<b>510</b> Swift-Fit Universal Push-In Fittings 89000 Series

AIGNEP

<b>512</b> Food Quality Push-In Fittings

## PUSH-IN FITTINGS

Push-in fittings are a type of easily removed compression or quick connect fittings that allow tool-free attachment of air or water lines.

## FESTO

New Additions



**513**  
Push-In & Threaded Fittings



**519**  
Mini Push-In Fittings

## CANDZZI Automation



**522**  
Super Rapid Push-In Fittings



**527**  
Micro Super Rapid Push-In Fittings

## CD PNEUMATICS



**529**  
Fluidfit Fittings Metric



**534**  
Fluidfit Fittings Imperial

## John Guest



**538**  
Air & Pneumatic Fittings Metric



**541**  
Air & Pneumatic Fittings Imperial

## STAINLESS STEEL PUSH-IN FITTINGS

### AIGNEP



**543**  
Stainless Steel One-Touch Fittings 60000 Series

### PARKAIR

New Additions



**545**  
316L Stainless Steel Push-In Fittings



# CDC One Touch 20 Bar Fittings

## Features

- Smaller fittings, featuring wider working pressure and temperature ranges
- One touch, push-to-connect configuration allows instant tubing connection
- Main body of PL and PT types are swivel for ease of piping
- Threads are Teflon™ coated or has an O-ring seal
- White release sleeve for easy identification

## Applications

- One touch type pipe connection for air pressure piping
- Various uses depending on the user's requirements

## Specifications

Suitability	Air (no other type of gas or liquid) <b>Do not use in water applications</b>
Working pressure	0 to 290 psi (20 bar)
Negative pressure	-29.5 in Hg / -750 mm Hg (-750 Torr)
Working temperature	-20°C to +80°C (-4°F to +176°F)
Application tube	Polyurethane and nylon

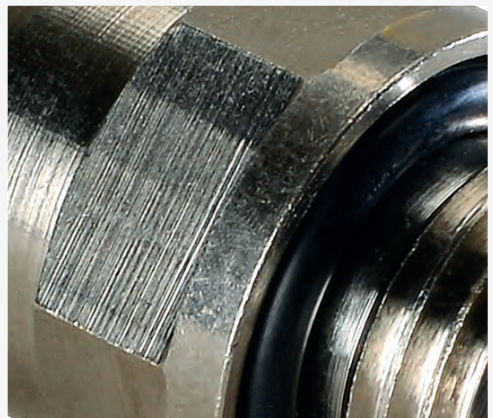
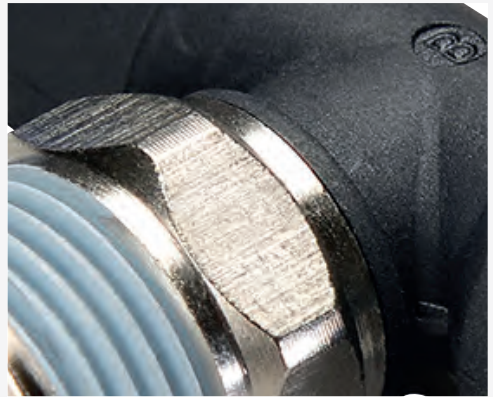
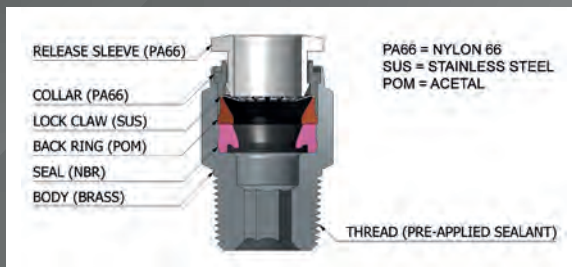

## WHITE

### STRAIGHT BSPT MALE



3700

PART NUMBER	TUBE OD	THREAD	BAG QTY
CDMPC0401NW	4 mm	1/8" BSPT	10
CDMPC0402NW	4 mm	1/4" BSPT	10
CDMPC0403NW	4 mm	3/8" BSPT	10
CDMPC0601NW	6 mm	1/8" BSPT	10
CDMPC0602NW	6 mm	1/4" BSPT	10
CDMPC0603NW	6 mm	3/8" BSPT	10
CDMPC0604NW	6 mm	1/2" BSPT	10
CDMPC0801NW	8 mm	1/8" BSPT	10
CDMPC0802NW	8 mm	1/4" BSPT	10
CDMPC0803NW	8 mm	3/8" BSPT	10
CDMPC0804NW	8 mm	1/2" BSPT	10
CDMPC1001NW	10 mm	1/8" BSPT	10
CDMPC1002NW	10 mm	1/4" BSPT	10
CDMPC1003NW	10 mm	3/8" BSPT	10
CDMPC1004NW	10 mm	1/2" BSPT	10
CDMPC1201NW	12 mm	1/8" BSPT	10
CDMPC1202NW	12 mm	1/4" BSPT	10
CDMPC1203NW	12 mm	3/8" BSPT	10
CDMPC1204NW	12 mm	1/2" BSPT	10

## BLACK

### STRAIGHT BSPT MALE



3700

PART NUMBER	TUBE OD	THREAD	BAG QTY
<b>CDMPC0401</b>	4 mm	1/8" BSPT	10
<b>CDMPC0402</b>	4 mm	1/4" BSPT	10
<b>CDMPC0403</b>	4 mm	3/8" BSPT	10
<b>CDMPC0601</b>	6 mm	1/8" BSPT	10
<b>CDMPC0602</b>	6 mm	1/4" BSPT	10
<b>CDMPC0603</b>	6 mm	3/8" BSPT	10
<b>CDMPC0604</b>	6 mm	1/2" BSPT	10
<b>CDMPC0801</b>	8 mm	1/8" BSPT	10
<b>CDMPC0802</b>	8 mm	1/4" BSPT	10
<b>CDMPC0803</b>	8 mm	3/8" BSPT	10
<b>CDMPC0804</b>	8 mm	1/2" BSPT	10
<b>CDMPC1001</b>	10 mm	1/8" BSPT	10
<b>CDMPC1002</b>	10 mm	1/4" BSPT	10
<b>CDMPC1003</b>	10 mm	3/8" BSPT	10
<b>CDMPC1004</b>	10 mm	1/2" BSPT	10
<b>CDMPC1201</b>	12 mm	1/8" BSPT	10
<b>CDMPC1202</b>	12 mm	1/4" BSPT	10
<b>CDMPC1203</b>	12 mm	3/8" BSPT	10
<b>CDMPC1204</b>	12 mm	1/2" BSPT	10

### STRAIGHT METRIC MALE WITH O-RING



3700

PART NUMBER	TUBE OD	THREAD	BAG QTY
CDMPC04M5NW	4 mm	M5 x 0.8	10
CDMPC04M6NW	4 mm	M6 x 1.0	10
CDMPC06M5NW	6 mm	M5 x 0.8	10
CDMPC06M6NW	6 mm	M6 x 1.0	10

### STRAIGHT METRIC MALE WITH O-RING



3700

PART NUMBER	TUBE OD	THREAD	BAG QTY
<b>CDMPC04M5</b>	4 mm	M5 x 0.8	10
<b>CDMPC04M6</b>	4 mm	M6 x 1.0	10
<b>CDMPC06M5</b>	6 mm	M5 x 0.8	10
<b>CDMPC06M6</b>	6 mm	M6 x 1.0	10

### BSPP MALE WITH O-RING

CDMPC04G01W	4 mm	1/8" BSPP	10
CDMPC04G02W	4 mm	1/4" BSPP	10
CDMPC04G03W	4 mm	3/8" BSPP	10
CDMPC06G01W	6 mm	1/8" BSPP	10
CDMPC06G02W	6 mm	1/4" BSPP	10
CDMPC06G03W	6 mm	3/8" BSPP	10
CDMPC06G04W	6 mm	1/2" BSPP	10
CDMPC08G01W	8 mm	1/8" BSPP	10
CDMPC08G02W	8 mm	1/4" BSPP	10
CDMPC08G03W	8 mm	3/8" BSPP	10
CDMPC08G04W	8 mm	1/2" BSPP	10
CDMPC10G01W	10 mm	1/8" BSPP	10
CDMPC10G02W	10 mm	1/4" BSPP	10
CDMPC10G03W	10 mm	3/8" BSPP	10
CDMPC10G04W	10 mm	1/2" BSPP	10
CDMPC12G02W	12 mm	1/4" BSPP	10
CDMPC12G03W	12 mm	3/8" BSPP	10
CDMPC12G04W	12 mm	1/2" BSPP	10

### BSPP MALE WITH O-RING

<b>CDMPC04G01</b>	4 mm	1/8" BSPP	10
<b>CDMPC04G02</b>	4 mm	1/4" BSPP	10
<b>CDMPC04G03</b>	4 mm	3/8" BSPP	10
<b>CDMPC06G01</b>	6 mm	1/8" BSPP	10
<b>CDMPC06G02</b>	6 mm	1/4" BSPP	10
<b>CDMPC06G03</b>	6 mm	3/8" BSPP	10
<b>CDMPC06G04</b>	6 mm	1/2" BSPP	10
<b>CDMPC08G01</b>	8 mm	1/8" BSPP	10
<b>CDMPC08G02</b>	8 mm	1/4" BSPP	10
<b>CDMPC08G03</b>	8 mm	3/8" BSPP	10
<b>CDMPC08G04</b>	8 mm	1/2" BSPP	10
<b>CDMPC10G01</b>	10 mm	1/8" BSPP	10
<b>CDMPC10G02</b>	10 mm	1/4" BSPP	10
<b>CDMPC10G03</b>	10 mm	3/8" BSPP	10
<b>CDMPC10G04</b>	10 mm	1/2" BSPP	10
<b>CDMPC12G02</b>	12 mm	1/4" BSPP	10
<b>CDMPC12G03</b>	12 mm	3/8" BSPP	10
<b>CDMPC12G04</b>	12 mm	1/2" BSPP	10

### STRAIGHT UNION



3700

PART NUMBER	TUBE OD	TUBE OD	BAG QTY
CDMPUC04W	4 mm	4 mm	10
CDMPUC06W	6 mm	6 mm	10
CDMPUC08W	8 mm	8 mm	10
CDMPUC10W	10 mm	10 mm	10
CDMPUC12W	12 mm	12 mm	5

### STRAIGHT UNION



3700

PART NUMBER	TUBE OD	BAG QTY
<b>CDMPUC04</b>	4 mm	10
<b>CDMPUC06</b>	6 mm	10
<b>CDMPUC08</b>	8 mm	10
<b>CDMPUC10</b>	10 mm	10
<b>CDMPUC12</b>	12 mm	5



## WHITE

## BLACK

### REDUCER



3700

PART NUMBER	TUBE OD	TUBE OD	BAG QTY
CD0604W	6 mm	4 mm	10
CDMPG0804W	8 mm	4 mm	10
CDMPG0806W	8 mm	6 mm	10
CDMPG1006W	10 mm	6 mm	10
CDMPG1008W	10 mm	8 mm	10
CDMPG1208W	12 mm	8 mm	10
CDMPG1210W	12 mm	10 mm	10

### REDUCER



3700

PART NUMBER	TUBE OD	TUBE OD	BAG QTY
<b>CDMPG0604</b>	6 mm	4 mm	10
<b>CDMPG0804</b>	8 mm	4 mm	10
<b>CDMPG0806</b>	8 mm	6 mm	10
<b>CDMPG1006</b>	10 mm	6 mm	10
<b>CDMPG1008</b>	10 mm	8 mm	10
<b>CDMPG1208</b>	12 mm	8 mm	10
<b>CDMPG1210</b>	12 mm	10 mm	10

### QUICK EXHAUST VALVE



3700

PART NUMBER	TUBE OD	TUBE OD	BAG QTY
CDMEVU0404W	4 mm	4 mm	10
CDMEVU0606W	6 mm	6 mm	10

### QUICK EXHAUST VALVE



3700

PART NUMBER	TUBE OD	BAG QTY
<b>CDMEVU0404</b>	4 mm	10
<b>CDMEVU0606</b>	6 mm	10

### UNION ELBOW



3700

PART NUMBER	TUBE OD	TUBE OD	BAG QTY
CDMPUL04W	4 mm	4 mm	10
CDMPUL06W	6 mm	6 mm	10
CDMPUL08W	8 mm	8 mm	10
CDMPUL10W	10 mm	10 mm	10
CDMPUL12W	12 mm	12 mm	5

### UNION ELBOW



3700

PART NUMBER	TUBE OD	BAG QTY
<b>CDMPUL04</b>	4 mm	10
<b>CDMPUL06</b>	6 mm	10
<b>CDMPUL08</b>	8 mm	10
<b>CDMPUL10</b>	10 mm	10
<b>CDMPUL12</b>	12 mm	5

### UNION TEE SOLD IN PACKS OF 10



3700

PART NUMBER	TUBE OD	TUBE OD	BAG QTY
CDMPUT04W	4 mm	4 mm	10
CDMPUT06W	6 mm	6 mm	10
CDMPUT08W	8 mm	8 mm	10
CDMPUT10W	10 mm	10 mm	5
CDMPUT12W	12 mm	12 mm	5

### UNION TEE SOLD IN PACKS OF 10



3700

PART NUMBER	TUBE OD	BAG QTY
<b>CDMPUT04</b>	4 mm	10
<b>CDMPUT06</b>	6 mm	10
<b>CDMPUT08</b>	8 mm	10
<b>CDMPUT10</b>	10 mm	5
<b>CDMPUT12</b>	12 mm	5

### UNION Y SOLD IN PACKS OF 10



3700

PART NUMBER	TUBE OD	TUBE OD	BAG QTY
CDMPY04W	4 mm	4 mm	10
CDMPY06W	6 mm	6 mm	10
CDMPY08W	8 mm	8 mm	10
CDMPY10W	10 mm	10 mm	5
CDMPY12W	12 mm	12 mm	5

### UNION Y SOLD IN PACKS OF 10



3700

PART NUMBER	TUBE OD	BAG QTY
<b>CDMPY04</b>	4 mm	10
<b>CDMPY06</b>	6 mm	10
<b>CDMPY08</b>	8 mm	10
<b>CDMPY10</b>	10 mm	5
<b>CDMPY12</b>	12 mm	5

## WHITE



**SWIVEL ELBOW  
BSPT MALE**

3700

PART NUMBER	TUBE OD	THREAD	BAG QTY
CDMPL0401NW	4 mm	1/8" BSPT	10
CDMPL0402NW	4 mm	1/4" BSPT	10
CDMPL0403NW	4 mm	3/8" BSPT	10
CDMPL0601NW	6 mm	1/8" BSPT	10
CDMPL0602NW	6 mm	1/4" BSPT	10
CDMPL0603NW	6 mm	3/8" BSPT	10
CDMPL0604NW	6 mm	1/2" BSPT	10
CDMPL0801NW	8 mm	1/8" BSPT	10
CDMPL0802NW	8 mm	1/4" BSPT	10
CDMPL0803NW	8 mm	3/8" BSPT	10
CDMPL0804NW	8 mm	1/2" BSPT	10
CDMPL1001NW	10 mm	1/8" BSPT	10
CDMPL1002NW	10 mm	1/4" BSPT	10
CDMPL1003NW	10 mm	3/8" BSPT	10
CDMPL1004NW	10 mm	1/2" BSPT	5
CDMPL1201NW	12 mm	1/8" BSPT	5
CDMPL1202NW	12 mm	1/4" BSPT	5
CDMPL1203NW	12 mm	3/8" BSPT	5
CDMPL1204NW	12 mm	1/2" BSPT	5

## BLACK



**SWIVEL ELBOW  
BSPT MALE**

3700

PART NUMBER	TUBE OD	THREAD	BAG QTY
<b>CDMPL0401</b>	4 mm	1/8" BSPT	10
<b>CDMPL0402</b>	4 mm	1/4" BSPT	10
<b>CDMPL0403</b>	4 mm	3/8" BSPT	10
<b>CDMPL0601</b>	6 mm	1/8" BSPT	10
<b>CDMPL0602</b>	6 mm	1/4" BSPT	10
<b>CDMPL0603</b>	6 mm	3/8" BSPT	10
<b>CDMPL0604</b>	6 mm	1/2" BSPT	10
<b>CDMPL0801</b>	8 mm	1/8" BSPT	10
<b>CDMPL0802</b>	8 mm	1/4" BSPT	10
<b>CDMPL0803</b>	8 mm	3/8" BSPT	10
<b>CDMPL0804</b>	8 mm	1/2" BSPT	10
<b>CDMPL1001</b>	10 mm	1/8" BSPT	10
<b>CDMPL1002</b>	10 mm	1/4" BSPT	10
<b>CDMPL1003</b>	10 mm	3/8" BSPT	10
<b>CDMPL1004</b>	10 mm	1/2" BSPT	5
<b>CDMPL1201</b>	12 mm	1/8" BSPT	5
<b>CDMPL1202</b>	12 mm	1/4" BSPT	5
<b>CDMPL1203</b>	12 mm	3/8" BSPT	5
<b>CDMPL1204</b>	12 mm	1/2" BSPT	5

**SWIVEL BRANCH TEE  
BSPT MALE**



3700

PART NUMBER	TUBE OD	THREAD	BAG QTY
CDMPT0401NW	4 mm	1/8" BSPT	10
CDMPT0402NW	4 mm	1/4" BSPT	10
CDMPT0403NW	4 mm	3/8" BSPT	10
CDMPT0601NW	6 mm	1/8" BSPT	10
CDMPT0602NW	6 mm	1/4" BSPT	10
CDMPT0603NW	6 mm	3/8" BSPT	10
CDMPT0604NW	6 mm	1/2" BSPT	5
CDMPT0801NW	8 mm	1/8" BSPT	10
CDMPT0802NW	8 mm	1/4" BSPT	10
CDMPT0803NW	8 mm	3/8" BSPT	10
CDMPT0804NW	8 mm	1/2" BSPT	5
CDMPT1001NW	10 mm	1/8" BSPT	5
CDMPT1002NW	10 mm	1/4" BSPT	5
CDMPT1003NW	10 mm	3/8" BSPT	5
CDMPT1004NW	10 mm	1/2" BSPT	5
CDMPT1201NW	12 mm	1/8" BSPT	5
CDMPT1202NW	12 mm	1/4" BSPT	5
CDMPT1203NW	12 mm	3/8" BSPT	5
CDMPT1204NW	12 mm	1/2" BSPT	5

**SWIVEL BRANCH TEE  
BSPT MALE**



3700

PART NUMBER	TUBE OD	THREAD	BAG QTY
<b>CDMPT0401</b>	4 mm	1/8" BSPT	10
<b>CDMPT0402</b>	4 mm	1/4" BSPT	10
<b>CDMPT0403</b>	4 mm	3/8" BSPT	10
<b>CDMPT0601</b>	6 mm	1/8" BSPT	10
<b>CDMPT0602</b>	6 mm	1/4" BSPT	10
<b>CDMPT0603</b>	6 mm	3/8" BSPT	10
<b>CDMPT0604</b>	6 mm	1/2" BSPT	5
<b>CDMPT0801</b>	8 mm	1/8" BSPT	10
<b>CDMPT0802</b>	8 mm	1/4" BSPT	10
<b>CDMPT0803</b>	8 mm	3/8" BSPT	10
<b>CDMPT0804</b>	8 mm	1/2" BSPT	5
<b>CDMPT1001</b>	10 mm	1/8" BSPT	5
<b>CDMPT1002</b>	10 mm	1/4" BSPT	5
<b>CDMPT1003</b>	10 mm	3/8" BSPT	5
<b>CDMPT1004</b>	10 mm	1/2" BSPT	5
<b>CDMPT1201</b>	12 mm	1/8" BSPT	5
<b>CDMPT1202</b>	12 mm	1/4" BSPT	5
<b>CDMPT1203</b>	12 mm	3/8" BSPT	5
<b>CDMPT1204</b>	12 mm	1/2" BSPT	5

## WHITE

### SWIVEL ELBOW METRIC MALE WITH O-RING



3700

PART NUMBER	TUBE OD	THREAD	BAG QTY
CDMPL04M5NW	4 mm	M5 x 0.8	10
CDMPL04M6NW	4 mm	M6 x 1.0	10
CDMPL06M5NW	6 mm	M5 x 0.8	10
CDMPL06M6NW	6 mm	M6 x 1.0	10

### BSPP MALE WITH O-RING

CDMPL04G01W	4 mm	1/8" BSPP	10
CDMPL04G02W	4 mm	1/4" BSPP	10
CDMPL04G03W	4 mm	3/8" BSPP	10
CDMPL04G04W	4 mm	1/2" BSPP	10
CDMPL06G01W	6 mm	1/8" BSPP	10
CDMPL06G02W	6 mm	1/4" BSPP	10
CDMPL06G03W	6 mm	3/8" BSPP	10
CDMPL06G04W	6 mm	1/2" BSPP	10
CDMPL08G01W	8 mm	1/8" BSPP	10
CDMPL08G02W	8 mm	1/4" BSPP	10
CDMPL08G03W	8 mm	3/8" BSPP	10
CDMPL08G04W	8 mm	1/2" BSPP	10
CDMPL10G01W	10 mm	1/8" BSPP	10
CDMPL10G02W	10 mm	1/4" BSPP	10
CDMPL10G03W	10 mm	3/8" BSPP	5
CDMPL10G04W	10 mm	1/2" BSPP	5
CDMPL12G01W	12 mm	1/8" BSPP	5
CDMPL12G02W	12 mm	1/4" BSPP	5
CDMPL12G03W	12 mm	3/8" BSPP	5
CDMPL12G04W	12 mm	1/2" BSPP	5

## BLACK

New

### SWIVEL ELBOW METRIC MALE WITH O-RING



3700

PART NUMBER	TUBE OD	THREAD	BAG QTY
CDMPL04M5	4 mm	M5 x 0.8	10
CDMPL04M6	4 mm	M6 x 1.0	10
CDMPL06M5	6 mm	M5 x 0.8	10
CDMPL06M6	6 mm	M6 x 1.0	10

### BSPP MALE WITH O-RING

CDMPL04G01	4 mm	1/8" BSPP	10
CDMPL04G02	4 mm	1/4" BSPP	10
CDMPL04G03	4 mm	3/8" BSPP	10
CDMPL06G01	6 mm	1/8" BSPP	10
CDMPL06G02	6 mm	1/4" BSPP	10
CDMPL06G03	6 mm	3/8" BSPP	10
CDMPL06G04	6 mm	1/2" BSPP	10
CDMPL08G01	8 mm	1/8" BSPP	10
CDMPL08G02	8 mm	1/4" BSPP	10
CDMPL08G03	8 mm	3/8" BSPP	10
CDMPL08G04	8 mm	1/2" BSPP	10
CDMPL10G01	10 mm	1/8" BSPP	10
CDMPL10G02	10 mm	1/4" BSPP	10
CDMPL10G03	10 mm	3/8" BSPP	10
CDMPL10G04	10 mm	1/2" BSPP	5
CDMPL12G02	12 mm	1/4" BSPP	5
CDMPL12G03	12 mm	3/8" BSPP	5
CDMPL12G04	12 mm	1/2" BSPP	5

Eight

### SWIVEL BRANCH TEE METRIC WITH O-RING



3700

PART NUMBER	TUBE OD	THREAD	BAG QTY
CDMPT04M5NW	4 mm	M5 x 0.8	10
CDMPT04M6NW	4 mm	M6 x 1.0	10
CDMPT06M5NW	6 mm	M5 x 0.8	10
CDMPT06M6NW	6 mm	M6 x 1.0	10

### BSPP MALE WITH O-RING

CDMPT04G01W	4 mm	1/8" BSPP	10
CDMPT04G02W	4 mm	1/4" BSPP	10
CDMPT04G03W	4 mm	3/8" BSPP	10
CDMPT04G04W	4 mm	1/2" BSPP	10
CDMPT06G01W	6 mm	1/8" BSPP	10
CDMPT06G02W	6 mm	1/4" BSPP	10
CDMPT06G03W	6 mm	3/8" BSPP	10
CDMPT06G04W	6 mm	1/2" BSPP	10
CDMPT08G01W	8 mm	1/8" BSPP	10
CDMPT08G02W	8 mm	1/4" BSPP	10
CDMPT08G03W	8 mm	3/8" BSPP	10
CDMPT08G04W	8 mm	1/2" BSPP	5
CDMPT10G01W	10 mm	1/8" BSPP	5
CDMPT10G02W	10 mm	1/4" BSPP	5
CDMPT10G03W	10 mm	3/8" BSPP	5
CDMPT10G04W	10 mm	1/2" BSPP	5
CDMPT12G01W	12 mm	1/8" BSPP	5
CDMPT12G02W	12 mm	1/4" BSPP	5
CDMPT12G03W	12 mm	3/8" BSPP	5
CDMPT12G04W	12 mm	1/2" BSPP	5

New

### SWIVEL BRANCH TEE METRIC MALE WITH O-RING



3700

PART NUMBER	TUBE OD	THREAD	BAG QTY
CDMPT04M5	4 mm	M5 x 0.8	10
CDMPT04M6	4 mm	M6 x 1.0	10
CDMPT06M5	6 mm	M5 x 0.8	10
CDMPT06M6	6 mm	M6 x 1.0	10

### BSPP MALE WITH O-RING

CDMPT04G01	4 mm	1/8" BSPP	10
CDMPT04G02	4 mm	1/4" BSPP	10
CDMPT04G03	4 mm	3/8" BSPP	10
CDMPT04G04	4 mm	1/2" BSPP	10
CDMPT06G01	6 mm	1/8" BSPP	10
CDMPT06G02	6 mm	1/4" BSPP	10
CDMPT06G03	6 mm	3/8" BSPP	10
CDMPT08G01	8 mm	1/8" BSPP	10
CDMPT08G02	8 mm	1/4" BSPP	10
CDMPT08G03	8 mm	3/8" BSPP	10
CDMPT08G04	8 mm	1/2" BSPP	5
CDMPT10G01	10 mm	1/8" BSPP	5
CDMPT10G02	10 mm	1/4" BSPP	5
CDMPT10G03	10 mm	3/8" BSPP	5
CDMPT10G04	10 mm	1/2" BSPP	5
CDMPT12G02	12 mm	1/4" BSPP	5
CDMPT12G03	12 mm	3/8" BSPP	5
CDMPT12G04	12 mm	1/2" BSPP	5

# CDC One Touch 10 Bar Fittings

## Features

- One touch, push-to-connect configuration allows instant tubing connection
- PC type has internal / external for ease of piping in limited spaces
- The main body of PL and PT types can swivel for ease of configuration
- Threads are Teflon™ coated or have an O-ring seal

## Applications

- One-touch type pipe connection tool for air pressure piping
- Various uses depending on the user's requirements

## Specifications

Suitability	Air (no other type of gas or liquid) <b>Do not use in water applications</b>
Working pressure	0 to 150 psi (10.3 bar)
Negative pressure	-29.5 in Hg / -750 mm Hg (-750 Torr)
Working temperature	0°C to +60°C (+32°F to +140°F)
Application tube	Polyurethane and nylon

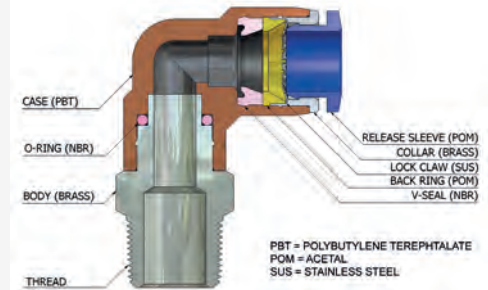

## TUBE TO THREAD



### STRAIGHT BSPT FEMALE

PART NUMBER	TUBE OD	THREAD	BAG QTY
CDPCF0401N	4 mm	1/8" BSPT	10
CDPCF0402N	4 mm	1/4" BSPT	10
CDPCF0403N	4 mm	3/8" BSPT	10
CDPCF0601N	6 mm	1/8" BSPT	10
CDPCF0602N	6 mm	1/4" BSPT	10
CDPCF0603N	6 mm	3/8" BSPT	10
CDPCF0801N	8 mm	1/8" BSPT	10
CDPCF0802N	8 mm	1/4" BSPT	10
CDPCF0803N	8 mm	3/8" BSPT	10
CDPCF0804N	8 mm	1/2" BSPT	10
CDPCF1001N	10 mm	1/8" BSPT	10
CDPCF1002N	10 mm	1/4" BSPT	10
CDPCF1003N	10 mm	3/8" BSPT	10
CDPCF1004N	10 mm	1/2" BSPT	10
CDPCF1202N	12 mm	1/4" BSPT	10
CDPCF1203N	12 mm	3/8" BSPT	10
CDPCF1204N	12 mm	1/2" BSPT	5



### STRAIGHT BSPP FEMALE

PART NUMBER	TUBE OD	THREAD	BAG QTY
CDPCF04G01	4 mm	1/8" BSPP	10
CDPCF04G02	4 mm	1/4" BSPP	10
CDPCF04G03	4 mm	3/8" BSPP	10
CDPCF06G01	6 mm	1/8" BSPP	10
CDPCF06G02	6 mm	1/4" BSPP	10
CDPCF06G03	6 mm	3/8" BSPP	10
CDPCF08G01	8 mm	1/8" BSPP	10
CDPCF08G02	8 mm	1/4" BSPP	10
CDPCF08G03	8 mm	3/8" BSPP	10
CDPCF08G04	8 mm	1/2" BSPP	10
CDPCF10G01	10 mm	1/8" BSPP	10
CDPCF10G02	10 mm	1/4" BSPP	10
CDPCF10G03	10 mm	3/8" BSPP	10
CDPCF10G04	10 mm	1/2" BSPP	10
CDPCF12G02	12 mm	1/4" BSPP	10
CDPCF12G03	12 mm	3/8" BSPP	10
CDPCF12G04	12 mm	1/2" BSPP	5

TUBE TO THREAD

STRAIGHT  
BSPT MALE



PART NUMBER	TUBE OD	THREAD	BAG QTY
CDPC0401N	4 mm	1/8" BSPT	10
CDPC0402N	4 mm	1/4" BSPT	10
CDPC0403N	4 mm	3/8" BSPT	10
CDPC0601N	6 mm	1/8" BSPT	10
CDPC0602N	6 mm	1/4" BSPT	10
CDPC0603N	6 mm	3/8" BSPT	10
CDPC0604N	6 mm	1/2" BSPT	10
CDPC0801N	8 mm	1/8" BSPT	10
CDPC0802N	8 mm	1/4" BSPT	10
CDPC0803N	8 mm	3/8" BSPT	10
CDPC0804N	8 mm	1/2" BSPT	10
CDPC1001N	10 mm	1/8" BSPT	10
CDPC1002N	10 mm	1/4" BSPT	10
CDPC1003N	10 mm	3/8" BSPT	10
CDPC1004N	10 mm	1/2" BSPT	10
CDPC1201N	12 mm	1/8" BSPT	10
CDPC1202N	12 mm	1/4" BSPT	10
CDPC1203N	12 mm	3/8" BSPT	10
CDPC1204N	12 mm	1/2" BSPT	10
CDPC1403N	14 mm	3/8" BSPT	5
CDPC1404N	14 mm	1/2" BSPT	5
CDPC1603N	16 mm	3/8" BSPT	5
CDPC1604N	16 mm	1/2" BSPT	5

STRAIGHT  
METRIC MALE



PART NUMBER	TUBE OD	THREAD	BAG QTY
CDPC04M5N	4 mm	M5 x 0.8	10
CDPC04M6N	4 mm	M6 x 1.0	10
CDPC06M5N	6 mm	M5 x 0.8	10
CDPC06M6N	6 mm	M6 x 1.0	10

BSPP MALE

PART NUMBER	TUBE OD	THREAD	BAG QTY
CDPC04G01	4 mm	1/8" BSPP	10
CDPC04G02	4 mm	1/4" BSPP	10
CDPC04G03	4 mm	3/8" BSPP	10
CDPC06G01	6 mm	1/8" BSPP	10
CDPC06G02	6 mm	1/4" BSPP	10
CDPC06G03	6 mm	3/8" BSPP	10
CDPC08G01	8 mm	1/8" BSPP	10
CDPC08G02	8 mm	1/4" BSPP	10
CDPC08G03	8 mm	3/8" BSPP	10
CDPC08G04	8 mm	1/2" BSPP	10
CDPC10G01	10 mm	1/8" BSPP	10
CDPC10G02	10 mm	1/4" BSPP	10
CDPC10G03	10 mm	3/8" BSPP	10
CDPC10G04	10 mm	1/2" BSPP	10
CDPC12G02	12 mm	1/4" BSPP	10
CDPC12G03	12 mm	3/8" BSPP	10
CDPC12G04	12 mm	1/2" BSPP	10
CDPC14G03	14 mm	3/8" BSPP	5
CDPC14G04	14 mm	1/2" BSPP	5
CDPC16G03	16 mm	3/8" BSPP	5
CDPC16G04	16 mm	1/2" BSPP	5

STRAIGHT ROUND  
BSPT MALE



PART NUMBER	TUBE OD	THREAD	BAG QTY
CDPOC0401N	4 mm	1/8" BSPT	10
CDPOC0402N	4 mm	1/4" BSPT	10
CDPOC0403N	4 mm	3/8" BSPT	10
CDPOC0601N	6 mm	1/8" BSPT	10
CDPOC0602N	6 mm	1/4" BSPT	10
CDPOC0603N	6 mm	3/8" BSPT	10
CDPOC0801N	8 mm	1/8" BSPT	10
CDPOC0802N	8 mm	1/4" BSPT	10
CDPOC0803N	8 mm	3/8" BSPT	10
CDPOC0804N	8 mm	1/2" BSPT	10
CDPOC1001N	10 mm	1/8" BSPT	10
CDPOC1002N	10 mm	1/4" BSPT	10
CDPOC1003N	10 mm	3/8" BSPT	10
CDPOC1004N	10 mm	1/2" BSPT	10
CDPOC1201N	12 mm	1/8" BSPT	10
CDPOC1202N	12 mm	1/4" BSPT	10
CDPOC1203N	12 mm	3/8" BSPT	10
CDPOC1204N	12 mm	1/2" BSPT	10

STRAIGHT ROUND  
METRIC MALE



PART NUMBER	TUBE OD	THREAD	BAG QTY
CDPOC04M5N	4 mm	M5 x 0.8	10
CDPOC04M6N	4 mm	M6 x 1.0	10
CDPOC06M5N	6 mm	M5 x 0.8	10
CDPOC06M6N	6 mm	M6 x 1.0	10

Do you also need?

**PARKAIR®**

Nylon tube



Find it on pages 660 – 664, section ten

## METRIC TUBE TO TUBE



EQUAL STRAIGHT UNION

3700



EQUAL UNION Y

3700

PART NUMBER	TUBE OD	BAG QTY
CDPUC04N	4 mm	10
CDPUC06N	6 mm	10
CDPUC08N	8 mm	10
CDPUC10N	10 mm	10
CDPUC12N	12 mm	5
CDPUC14N	14 mm	5
CDPUC16N	16 mm	5

PART NUMBER	TUBE OD	BAG QTY
CDPY04N	4 mm	10
CDPY06N	6 mm	10
CDPY08N	8 mm	10
CDPY10N	10 mm	5
CDPY12N	12 mm	5
CDPY16N	16 mm	3



EQUAL UNION TEE

3700



REDUCER Y

3700

PART NUMBER	TUBE OD	BAG QTY
CDPUT04N	4 mm	10
CDPUT06N	6 mm	10
CDPUT08N	8 mm	10
CDPUT10N	10 mm	5
CDPUT12N	12 mm	5
CDPUT14N	14 mm	3
CDPUT16N	16 mm	3

PART NUMBER	TUBE OD A	TUBE OD B	BAG QTY
CDPW0604	6 mm	4 mm	10
CDPW0804	8 mm	4 mm	10
CDPW0806	8 mm	6 mm	10
CDPW1006	10 mm	6 mm	10
CDPW1008	10 mm	8 mm	10
CDPW1208	12 mm	8 mm	5
CDPW1210	12 mm	10 mm	5
CDPW1612	16 mm	12 mm	3

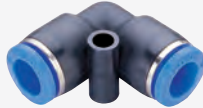

EQUAL UNION ELBOW

3700



UNION CROSS

3700

PART NUMBER	TUBE OD	BAG QTY
CDPUL04N	4 mm	10
CDPUL06N	6 mm	10
CDPUL08N	8 mm	10
CDPUL10N	10 mm	10
CDPUL12N	12 mm	5
CDPUL14N	14 mm	5
CDPUL16N	16 mm	5

PART NUMBER	TUBE OD	BAG QTY
CDPZA04N	4 mm	10
CDPZA06N	6 mm	10
CDPZA08N	8 mm	5
CDPZA10N	10 mm	5
CDPZA12N	12 mm	3



REDUCER TEE

3700



REDUCER

3700

PART NUMBER	TUBE OD A	TUBE OD B	BAG QTY
CDPGT0406N	4 mm	6 mm	10
CDPGT0604N	6 mm	4 mm	10
CDPGT0608N	6 mm	8 mm	10
CDPGT0806N	8 mm	6 mm	10
CDPGT0810N	8 mm	10 mm	10
CDPGT1006N	10 mm	6 mm	5
CDPGT1008N	10 mm	8 mm	5
CDPGT1012N	10 mm	12 mm	5
CDPGT1208N	12 mm	8 mm	5
CDPGT1210N	12 mm	10 mm	5
CDPGT1610N	16 mm	10 mm	3
CDPGT1612N	16 mm	12 mm	3

PART NUMBER	TUBE OD	TUBE OD	BAG QTY
CDPG0604N	6 mm	4 mm	10
CDPG0804N	8 mm	4 mm	10
CDPG0806N	8 mm	6 mm	10
CDPG1006N	10 mm	6 mm	10
CDPG1008N	10 mm	8 mm	10
CDPG1208N	12 mm	8 mm	10
CDPG1210N	12 mm	10 mm	10
CDPG1412N	14 mm	12 mm	5
CDPG1612N	16 mm	12 mm	5



METRIC TUBE TO TUBE



SWIVEL POSITIONAL ELBOW  
BSPT MALE

3700

PART NUMBER	TUBE OD	THREAD	BAG QTY
CDPL0401N	4 mm	1/8" BSPT	10
CDPL0402N	4 mm	1/4" BSPT	10
CDPL0403N	4 mm	3/8" BSPT	10
CDPL0601N	6 mm	1/8" BSPT	10
CDPL0602N	6 mm	1/4" BSPT	10
CDPL0603N	6 mm	3/8" BSPT	10
CDPL0604N	6 mm	1/2" BSPT	10
CDPL0801N	8 mm	1/8" BSPT	10
CDPL0802N	8 mm	1/4" BSPT	10
CDPL0803N	8 mm	3/8" BSPT	10
CDPL0804N	8 mm	1/2" BSPT	10
CDPL1001N	10 mm	1/8" BSPT	10
CDPL1002N	10 mm	1/4" BSPT	10
CDPL1003N	10 mm	3/8" BSPT	10
CDPL1004N	10 mm	1/2" BSPT	5
CDPL1201N	12 mm	1/8" BSPT	5
CDPL1202N	12 mm	1/4" BSPT	5
CDPL1203N	12 mm	3/8" BSPT	5
CDPL1204N	12 mm	1/2" BSPT	5
CDPL1403N	14 mm	3/8" BSPT	5
CDPL1404N	14 mm	1/2" BSPT	5
CDPL1603N	16 mm	3/8" BSPT	5
CDPL1604N	16 mm	1/2" BSPT	5



BULKHEAD UNION

3700

PART NUMBER	TUBE OD	BAG QTY
CDPMM04N	4 mm	10
CDPMM06N	6 mm	10
CDPMM08N	8 mm	10
CDPMM10N	10 mm	5
CDPMM12N	12 mm	5
CDPMM16N	16 mm	3



STRAIGHT BULKHEAD  
BSPT FEMALE

3700

PART NUMBER	TUBE OD	THREAD	BAG QTY
CDPMF0401N	4 mm	1/8" BSPT	10
CDPMF0402N	4 mm	1/4" BSPT	10
CDPMF0403N	4 mm	3/8" BSPT	10
CDPMF0601N	6 mm	1/8" BSPT	10
CDPMF0602N	6 mm	1/4" BSPT	10
CDPMF0603N	6 mm	3/8" BSPT	10
CDPMF0801N	8 mm	1/8" BSPT	10
CDPMF0802N	8 mm	1/4" BSPT	10
CDPMF0803N	8 mm	3/8" BSPT	10
CDPMF0804N	8 mm	1/2" BSPT	5
CDPMF1001N	10 mm	1/8" BSPT	10
CDPMF1002N	10 mm	1/4" BSPT	10
CDPMF1003N	10 mm	3/8" BSPT	5
CDPMF1004N	10 mm	1/2" BSPT	5
CDPMF1202N	12 mm	1/4" BSPT	5
CDPMF1203N	12 mm	3/8" BSPT	5
CDPMF1204N	12 mm	1/2" BSPT	5



SWIVEL ELBOW  
METRIC MALE

3700

PART NUMBER	TUBE OD	THREAD	BAG QTY
CDPL04M5N	4 mm	M5 x 0.8	10
CDPL04M6N	4 mm	M6 x 1.0	10
CDPL06M5N	6 mm	M5 x 0.8	10
CDPL06M6N	6 mm	M6 x 1.0	10

BSPP MALE

CDPL04G01	4 mm	1/8" BSPP	10
CDPL04G02	4 mm	1/4" BSPP	10
CDPL04G03	4 mm	3/8" BSPP	10
CDPL06G01	6 mm	1/8" BSPP	10
CDPL06G02	6 mm	1/4" BSPP	10
CDPL06G03	6 mm	3/8" BSPP	10
CDPL08G01	8 mm	1/8" BSPP	10
CDPL08G02	8 mm	1/4" BSPP	10
CDPL08G03	8 mm	3/8" BSPP	10
CDPL08G04	8 mm	1/2" BSPP	10
CDPL10G01	10 mm	1/8" BSPP	10
CDPL10G02	10 mm	1/4" BSPP	10
CDPL10G03	10 mm	3/8" BSPP	10
CDPL10G04	10 mm	1/2" BSPP	5
CDPL12G02	12 mm	1/4" BSPP	5
CDPL12G03	12 mm	3/8" BSPP	5
CDPL12G04	12 mm	1/2" BSPP	5
CDPL14G03	14 mm	3/8" BSPP	5
CDPL14G04	14 mm	1/2" BSPP	5
CDPL16G03	16 mm	3/8" BSPP	5
CDPL16G04	16 mm	1/2" BSPP	5



STRAIGHT BULKHEAD  
BSPP FEMALE

3700

PART NUMBER	TUBE OD	THREAD	BAG QTY
CDPMF04G01	4 mm	1/8" BSPP	10
CDPMF04G02	4 mm	1/4" BSPP	10
CDPMF04G03	4 mm	3/8" BSPP	10
CDPMF06G01	6 mm	1/8" BSPP	10
CDPMF06G02	6 mm	1/4" BSPP	10
CDPMF06G03	6 mm	3/8" BSPP	10
CDPMF08G01	8 mm	1/8" BSPP	10
CDPMF08G02	8 mm	1/4" BSPP	10
CDPMF08G03	8 mm	3/8" BSPP	10
CDPMF10G02	10 mm	1/4" BSPP	10
CDPMF10G03	10 mm	3/8" BSPP	5
CDPMF10G04	10 mm	1/2" BSPP	5
CDPMF12G02	12 mm	1/4" BSPP	5
CDPMF12G03	12 mm	3/8" BSPP	5
CDPMF12G04	12 mm	1/2" BSPP	5

TUBE TO THREAD

CAP



3700

PART NUMBER	TUBE OD	BAG QTY
CDPPF04N	4 mm	10
CDPPF06N	6 mm	10
CDPPF08N	8 mm	10
CDPPF10N	10 mm	10
CDPPF12N	12 mm	10
CDPPF16N	16 mm	10

SWIVEL ELBOW  
BSPT FEMALE



3700

PART NUMBER	TUBE OD	THREAD	BAG QTY
CDPLF0401N	4 mm	1/8" BSPT	10
CDPLF0601N	6 mm	1/8" BSPT	10
CDPLF0602N	6 mm	1/4" BSPT	10
CDPLF0603N	6 mm	3/8" BSPT	10
CDPLF0801N	8 mm	1/8" BSPT	10
CDPLF0802N	8 mm	1/4" BSPT	10
CDPLF0803N	8 mm	3/8" BSPT	10
CDPLF0804N	8 mm	1/2" BSPT	5
CDPLF1002N	10 mm	1/4" BSPT	5
CDPLF1003N	10 mm	3/8" BSPT	5
CDPLF1004N	10 mm	1/2" BSPT	5
CDPLF1202N	12 mm	1/4" BSPT	5
CDPLF1203N	12 mm	3/8" BSPT	5
CDPLF1204N	12 mm	1/2" BSPT	5

SWIVEL ELBOW  
METRIC FEMALE



3700

PART NUMBER	TUBE OD	THREAD	BAG QTY
CDPLF04M5N	4 mm	M5 x 0.8	10
CDPLF04M6N	4 mm	M6 x 1.0	10
CDPLF06M5N	6 mm	M5 x 0.8	10
CDPLF06M6N	6 mm	M6 x 1.0	10

BSPP FEMALE

CDPLF04G01	4 mm	1/8" BSPP	10
CDPLF04G02	4 mm	1/4" BSPP	10
CDPLF06G01	6 mm	1/8" BSPP	10
CDPLF06G02	6 mm	1/4" BSPP	10
CDPLF06G03	6 mm	3/8" BSPP	10
CDPLF08G01	8 mm	1/8" BSPP	10
CDPLF08G02	8 mm	1/4" BSPP	10
CDPLF08G03	8 mm	3/8" BSPP	10
CDPLF08G04	8 mm	1/2" BSPP	5
CDPLF10G01	10 mm	1/8" BSPP	5
CDPLF10G02	10 mm	1/4" BSPP	5
CDPLF10G03	10 mm	3/8" BSPP	5
CDPLF10G04	10 mm	1/2" BSPP	5
CDPLF12G02	12 mm	1/4" BSPP	5
CDPLF12G03	12 mm	3/8" BSPP	5
CDPLF12G04	12 mm	1/2" BSPP	5

SWIVEL BRANCH TEE  
BSPT MALE



3700

PART NUMBER	TUBE OD	THREAD	BAG QTY
CDPT0401N	4 mm	1/8" BSPT	10
CDPT0402N	4 mm	1/4" BSPT	10
CDPT0403N	4 mm	3/8" BSPT	10
CDPT0601N	6 mm	1/8" BSPT	10
CDPT0602N	6 mm	1/4" BSPT	10
CDPT0603N	6 mm	3/8" BSPT	10
CDPT0604N	6 mm	1/2" BSPT	5
CDPT0801N	8 mm	1/8" BSPT	10
CDPT0802N	8 mm	1/4" BSPT	10
CDPT0803N	8 mm	3/8" BSPT	10
CDPT0804N	8 mm	1/2" BSPT	5
CDPT1001N	10 mm	1/8" BSPT	5
CDPT1002N	10 mm	1/4" BSPT	5
CDPT1003N	10 mm	3/8" BSPT	5
CDPT1004N	10 mm	1/2" BSPT	5
CDPT1201N	12 mm	1/8" BSPT	5
CDPT1202N	12 mm	1/4" BSPT	5
CDPT1203N	12 mm	3/8" BSPT	5
CDPT1204N	12 mm	1/2" BSPT	5
CDPT1603N	16 mm	3/8" BSPT	3
CDPT1604N	16 mm	1/2" BSPT	3

SWIVEL BRANCH TEE  
METRIC MALE



3700

PART NUMBER	TUBE OD	THREAD	BAG QTY
CDPT04M5N	4 mm	M5 x 0.8	10
CDPT04M6N	4 mm	M6 x 1.0	10
CDPT06M5N	6 mm	M5 x 0.8	10
CDPT06M6N	6 mm	M6 x 1.0	10

BSPP MALE

CDPT04G01	4 mm	1/8" BSPP	10
CDPT04G02	4 mm	1/4" BSPP	10
CDPT04G03	4 mm	3/8" BSPP	10
CDPT06G01	6 mm	1/8" BSPP	10
CDPT06G02	6 mm	1/4" BSPP	10
CDPT06G03	6 mm	3/8" BSPP	10
CDPT08G01	8 mm	1/8" BSPP	10
CDPT08G02	8 mm	1/4" BSPP	10
CDPT08G03	8 mm	3/8" BSPP	10
CDPT08G04	8 mm	1/2" BSPP	5
CDPT10G01	10 mm	1/8" BSPP	5
CDPT10G02	10 mm	1/4" BSPP	5
CDPT10G03	10 mm	3/8" BSPP	5
CDPT10G04	10 mm	1/2" BSPP	5
CDPT12G02	12 mm	1/4" BSPP	5
CDPT12G03	12 mm	3/8" BSPP	5
CDPT12G04	12 mm	1/2" BSPP	5
CDPT16G03	16 mm	3/8" BSPP	3
CDPT16G04	16 mm	1/2" BSPP	3

TUBE TO THREAD



SWIVEL ROTATING BRANCH TEE  
BSPT FEMALE

3700



SWIVEL RUN TEE  
BSPT MALE

3700

PART NUMBER	TUBE OD	THREAD	BAG QTY
CDPTF0401N	4 mm	1/8" BSPT	10
CDPTF0402N	4 mm	1/4" BSPT	10
CDPTF0601N	6 mm	1/8" BSPT	10
CDPTF0602N	6 mm	1/4" BSPT	10
CDPTF0603N	6 mm	3/8" BSPT	5
CDPTF0801N	8 mm	1/8" BSPT	10
CDPTF0802N	8 mm	1/4" BSPT	5
CDPTF0803N	8 mm	3/8" BSPT	5
CDPTF1001N	10 mm	1/8" BSPT	5
CDPTF1002N	10 mm	1/4" BSPT	5
CDPTF1003N	10 mm	3/8" BSPT	5
CDPTF1004N	10 mm	1/2" BSPT	5
CDPTF1202N	12 mm	1/4" BSPT	5
CDPTF1203N	12 mm	3/8" BSPT	5
CDPTF1204N	12 mm	1/2" BSPT	5

PART NUMBER	TUBE OD	THREAD	BAG QTY
CDPST0401N	4 mm	1/8" BSPT	10
CDPST0402N	4 mm	1/4" BSPT	10
CDPST0403N	4 mm	3/8" BSPT	10
CDPST0601N	6 mm	1/8" BSPT	10
CDPST0602N	6 mm	1/4" BSPT	10
CDPST0603N	6 mm	3/8" BSPT	10
CDPST0604N	6 mm	1/2" BSPT	5
CDPST0801N	8 mm	1/8" BSPT	10
CDPST0802N	8 mm	1/4" BSPT	10
CDPST0803N	8 mm	3/8" BSPT	10
CDPST0804N	8 mm	1/2" BSPT	5
CDPST1001N	10 mm	1/8" BSPT	5
CDPST1002N	10 mm	1/4" BSPT	5
CDPST1003N	10 mm	3/8" BSPT	5
CDPST1004N	10 mm	1/2" BSPT	5
CDPST1201N	12 mm	1/8" BSPT	5
CDPST1202N	12 mm	1/4" BSPT	5
CDPST1203N	12 mm	3/8" BSPT	5
CDPST1204N	12 mm	1/2" BSPT	5



SWIVEL BRANCH TEE  
METRIC FEMALE

3700



SWIVEL RUN TEE  
METRIC MALE

3700

PART NUMBER	TUBE OD	THREAD	BAG QTY
CDPTF04M5N	4 mm	M5 x 0.8	10
CDPTF04M6N	4 mm	M6 x 1.0	10
CDPTF06M5N	6 mm	M5 x 0.8	10
CDPTF06M6N	6 mm	M6 x 1.0	10

PART NUMBER	TUBE OD	THREAD	BAG QTY
CDPST04M5N	4 mm	M5 x 0.8	10
CDPST04M6N	4 mm	M6 x 1.0	10
CDPST06M5N	6 mm	M5 x 0.8	10
CDPST06M6N	6 mm	M6 x 1.0	10

BSPP FEMALE

PART NUMBER	TUBE OD	THREAD	BAG QTY
CDPTF04G01	4 mm	1/8" BSPP	10
CDPTF04G02	4 mm	1/4" BSPP	10
CDPTF06G01	6 mm	1/8" BSPP	10
CDPTF06G02	6 mm	1/4" BSPP	10
CDPTF06G03	6 mm	3/8" BSPP	5
CDPTF08G01	8 mm	1/8" BSPP	10
CDPTF08G02	8 mm	1/4" BSPP	5
CDPTF08G03	8 mm	3/8" BSPP	5
CDPTF08G04	8 mm	1/2" BSPP	5
CDPTF10G01	10 mm	1/8" BSPP	5
CDPTF10G02	10 mm	1/4" BSPP	5
CDPTF10G03	10 mm	3/8" BSPP	5
CDPTF10G04	10 mm	1/2" BSPP	5
CDPTF12G02	12 mm	1/4" BSPP	5
CDPTF12G03	12 mm	3/8" BSPP	5
CDPTF12G04	12 mm	1/2" BSPP	5

BSPP MALE

PART NUMBER	TUBE OD	THREAD	BAG QTY
CDPST04G01	4 mm	1/8" BSPP	10
CDPST04G02	4 mm	1/4" BSPP	10
CDPST04G03	4 mm	3/8" BSPP	10
CDPST06G01	6 mm	1/8" BSPP	10
CDPST06G02	6 mm	1/4" BSPP	10
CDPST06G03	6 mm	3/8" BSPP	10
CDPST08G01	8 mm	1/8" BSPP	10
CDPST08G02	8 mm	1/4" BSPP	10
CDPST08G03	8 mm	3/8" BSPP	10
CDPST08G04	8 mm	1/2" BSPP	5
CDPST10G01	10 mm	1/8" BSPP	5
CDPST10G02	10 mm	1/4" BSPP	5
CDPST10G03	10 mm	3/8" BSPP	5
CDPST10G04	10 mm	1/2" BSPP	5
CDPST12G02	12 mm	1/4" BSPP	5
CDPST12G03	12 mm	3/8" BSPP	5
CDPST12G04	12 mm	1/2" BSPP	5

TUBE TO THREAD



SWIVEL Y  
BSPT MALE

3700

PART NUMBER	TUBE OD	THREAD	BAG QTY
CDPWT0401N	4 mm	1/8" BSPT	10
CDPWT0402N	4 mm	1/4" BSPT	10
CDPWT0403N	4 mm	3/8" BSPT	10
CDPWT0601N	6 mm	1/8" BSPT	10
CDPWT0602N	6 mm	1/4" BSPT	10
CDPWT0603N	6 mm	3/8" BSPT	10
CDPWT0604N	6 mm	1/2" BSPT	5
CDPWT0801N	8 mm	1/8" BSPT	10
CDPWT0802N	8 mm	1/4" BSPT	10
CDPWT0803N	8 mm	3/8" BSPT	10
CDPWT0804N	8 mm	1/2" BSPT	5
CDPWT1001N	10 mm	1/8" BSPT	5
CDPWT1002N	10 mm	1/4" BSPT	5
CDPWT1003N	10 mm	3/8" BSPT	5
CDPWT1004N	10 mm	1/2" BSPT	5
CDPWT1201N	12 mm	1/8" BSPT	5
CDPWT1202N	12 mm	1/4" BSPT	5
CDPWT1203N	12 mm	3/8" BSPT	5
CDPWT1204N	12 mm	1/2" BSPT	5



45° ELBOW  
BSPT MALE

3700

PART NUMBER	TUBE OD	THREAD	BAG QTY
CDPL450401N	4 mm	1/8" BSPT	10
CDPL450402N	4 mm	1/4" BSPT	10
CDPL450403N	4 mm	3/8" BSPT	10
CDPL450601N	6 mm	1/8" BSPT	10
CDPL450602N	6 mm	1/4" BSPT	10
CDPL450603N	6 mm	3/8" BSPT	10
CDPL450604N	6 mm	1/2" BSPT	10
CDPL450801N	8 mm	1/8" BSPT	10
CDPL450802N	8 mm	1/4" BSPT	10
CDPL450803N	8 mm	3/8" BSPT	10
CDPL450804N	8 mm	1/2" BSPT	10
CDPL451001N	10 mm	1/8" BSPT	10
CDPL451002N	10 mm	1/4" BSPT	10
CDPL451003N	10 mm	3/8" BSPT	10
CDPL451004N	10 mm	1/2" BSPT	5
CDPL451201N	12 mm	1/8" BSPT	5
CDPL451202N	12 mm	1/4" BSPT	5
CDPL451203N	12 mm	3/8" BSPT	5
CDPL451204N	12 mm	1/2" BSPT	5



SWIVEL Y  
METRIC MALE

3700

PART NUMBER	TUBE OD	THREAD	BAG QTY
CDPWT04M5N	4 mm	M5 x 0.8	10
CDPWT04M6N	4 mm	M6 x 1.0	10
CDPWT06M5N	6 mm	M5 x 0.8	10
CDPWT06M6N	6 mm	M6 x 1.0	10

BSPP MALE

PART NUMBER	TUBE OD	THREAD	BAG QTY
CDPWT04G01	4 mm	1/8" BSPP	10
CDPWT04G02	4 mm	1/4" BSPP	10
CDPWT04G03	4 mm	3/8" BSPP	10
CDPWT06G01	6 mm	1/8" BSPP	10
CDPWT06G02	6 mm	1/4" BSPP	10
CDPWT06G03	6 mm	3/8" BSPP	10
CDPWT08G01	8 mm	1/8" BSPP	10
CDPWT08G02	8 mm	1/4" BSPP	10
CDPWT08G03	8 mm	3/8" BSPP	10
CDPWT08G04	8 mm	1/2" BSPP	5
CDPWT10G01	10 mm	1/8" BSPP	5
CDPWT10G02	10 mm	1/4" BSPP	5
CDPWT10G03	10 mm	3/8" BSPP	5
CDPWT10G04	10 mm	1/2" BSPP	5
CDPWT12G02	12 mm	1/4" BSPP	5
CDPWT12G03	12 mm	3/8" BSPP	5
CDPWT12G04	12 mm	1/2" BSPP	5



45° ELBOW  
METRIC MALE

3700

PART NUMBER	TUBE OD	THREAD	BAG QTY
CDPL4504M5N	4 mm	M5 x 0.8	10
CDPL4504M6N	4 mm	M6 x 1.0	10
CDPL4506M5N	6 mm	M5 x 0.8	10
CDPL4506M6N	6 mm	M6 x 1.0	10

BSPP MALE

PART NUMBER	TUBE OD	THREAD	BAG QTY
CDPL4504G01	4 mm	1/8" BSPP	10
CDPL4504G02	4 mm	1/4" BSPP	10
CDPL4504G03	4 mm	3/8" BSPP	10
CDPL4506G01	6 mm	1/8" BSPP	10
CDPL4506G02	6 mm	1/4" BSPP	10
CDPL4506G03	6 mm	3/8" BSPP	10
CDPL4506G04	6 mm	1/2" BSPP	10
CDPL4508G01	8 mm	1/8" BSPP	10
CDPL4508G02	8 mm	1/4" BSPP	10
CDPL4508G03	8 mm	3/8" BSPP	10
CDPL4508G04	8 mm	1/2" BSPP	10
CDPL4510G01	10 mm	1/8" BSPP	10
CDPL4510G02	10 mm	1/4" BSPP	10
CDPL4510G03	10 mm	3/8" BSPP	10
CDPL4510G04	10 mm	1/2" BSPP	5
CDPL4512G02	12 mm	1/4" BSPP	5
CDPL4512G03	12 mm	3/8" BSPP	5
CDPL4512G04	12 mm	1/2" BSPP	5

TUBE TO THREAD



SWIVEL EXTENDED ELBOW  
BSPT MALE

3700

PART NUMBER	TUBE OD	THREAD	BAG QTY
CDPLL0401N	4 mm	1/8" BSPT	10
CDPLL0402N	4 mm	1/4" BSPT	10
CDPLL0403N	4 mm	3/8" BSPT	10
CDPLL0601N	6 mm	1/8" BSPT	10
CDPLL0602N	6 mm	1/4" BSPT	10
CDPLL0603N	6 mm	3/8" BSPT	10
CDPLL0604N	6 mm	1/2" BSPT	5
CDPLL0801N	8 mm	1/8" BSPT	10
CDPLL0802N	8 mm	1/4" BSPT	10
CDPLL0803N	8 mm	3/8" BSPT	5
CDPLL0804N	8 mm	1/2" BSPT	5
CDPLL1001N	10 mm	1/8" BSPT	5
CDPLL1002N	10 mm	1/4" BSPT	5
CDPLL1003N	10 mm	3/8" BSPT	5
CDPLL1004N	10 mm	1/2" BSPT	5
CDPLL1201N	12 mm	1/8" BSPT	5
CDPLL1202N	12 mm	1/4" BSPT	5
CDPLL1203N	12 mm	3/8" BSPT	5
CDPLL1204N	12 mm	1/2" BSPT	5



SWIVEL EXTENDED ELBOW  
BSPT MALE

3700

PART NUMBER	TUBE OD	THREAD	BAG QTY
CDPLL0401N	4 mm	1/8" BSPT	10
CDPLL0402N	4 mm	1/4" BSPT	10
CDPLL0403N	4 mm	3/8" BSPT	10
CDPLL0601N	6 mm	1/8" BSPT	10
CDPLL0602N	6 mm	1/4" BSPT	10
CDPLL0603N	6 mm	3/8" BSPT	10
CDPLL0604N	6 mm	1/2" BSPT	5
CDPLL0801N	8 mm	1/8" BSPT	10
CDPLL0802N	8 mm	1/4" BSPT	10
CDPLL0803N	8 mm	3/8" BSPT	5
CDPLL0804N	8 mm	1/2" BSPT	5
CDPLL1001N	10 mm	1/8" BSPT	5
CDPLL1002N	10 mm	1/4" BSPT	5
CDPLL1003N	10 mm	3/8" BSPT	5
CDPLL1004N	10 mm	1/2" BSPT	5
CDPLL1201N	12 mm	1/8" BSPT	5
CDPLL1202N	12 mm	1/4" BSPT	5
CDPLL1203N	12 mm	3/8" BSPT	5
CDPLL1204N	12 mm	1/2" BSPT	5



SWIVEL EXTENDED ELBOW  
METRIC MALE

3700

PART NUMBER	TUBE OD	THREAD	BAG QTY
CDPLL04M5N	4 mm	M5 x 0.8	10
CDPLL04M6N	4 mm	M6 x 1.0	10
CDPLL06M5N	6 mm	M5 x 0.8	10
CDPLL06M6N	6 mm	M6 x 1.0	10

BSPP MALE

CDPLL04G01	4 mm	1/8" BSPP	10
CDPLL04G02	4 mm	1/4" BSPP	10
CDPLL04G03	4 mm	3/8" BSPP	10
CDPLL06G01	6 mm	1/8" BSPP	10
CDPLL06G02	6 mm	1/4" BSPP	10
CDPLL06G03	6 mm	3/8" BSPP	10
CDPLL08G01	8 mm	1/8" BSPP	10
CDPLL08G02	8 mm	1/4" BSPP	10
CDPLL08G03	8 mm	3/8" BSPP	5
CDPLL08G04	8 mm	1/2" BSPP	5
CDPLL10G01	10 mm	1/8" BSPP	5
CDPLL10G02	10 mm	1/4" BSPP	5
CDPLL10G03	10 mm	3/8" BSPP	5
CDPLL10G04	10 mm	1/2" BSPP	5
CDPLL12G02	12 mm	1/4" BSPP	5
CDPLL12G03	12 mm	3/8" BSPP	5
CDPLL12G04	12 mm	1/2" BSPP	5



SWIVEL EXTENDED ELBOW  
METRIC MALE

3700

PART NUMBER	TUBE OD	THREAD	BAG QTY
CDPLL04M5N	4 mm	M5 x 0.8	10
CDPLL04M6N	4 mm	M6 x 1.0	10
CDPLL06M5N	6 mm	M5 x 0.8	10
CDPLL06M6N	6 mm	M6 x 1.0	10

BSPP MALE

CDPLL04G01	4 mm	1/8" BSPP	10
CDPLL04G02	4 mm	1/4" BSPP	10
CDPLL04G03	4 mm	3/8" BSPP	10
CDPLL06G01	6 mm	1/8" BSPP	10
CDPLL06G02	6 mm	1/4" BSPP	10
CDPLL06G03	6 mm	3/8" BSPP	10
CDPLL08G01	8 mm	1/8" BSPP	10
CDPLL08G02	8 mm	1/4" BSPP	10
CDPLL08G03	8 mm	3/8" BSPP	5
CDPLL08G04	8 mm	1/2" BSPP	5
CDPLL10G01	10 mm	1/8" BSPP	5
CDPLL10G02	10 mm	1/4" BSPP	5
CDPLL10G03	10 mm	3/8" BSPP	5
CDPLL10G04	10 mm	1/2" BSPP	5
CDPLL12G02	12 mm	1/4" BSPP	5
CDPLL12G03	12 mm	3/8" BSPP	5
CDPLL12G04	12 mm	1/2" BSPP	5

## TUBE TO THREAD



**DOUBLE Y  
BSPT MALE**

3700

PART NUMBER	TUBE OD	THREAD	BAG QTY
CDPXT0401	4 mm	1/8" BSPT	10
CDPXT0402	4 mm	1/4" BSPT	10
CDPXT0601	6 mm	1/8" BSPT	5
CDPXT0602	6 mm	1/4" BSPT	5



**DOUBLE Y  
BSPP MALE**

3700

PART NUMBER	TUBE OD	THREAD	BAG QTY
CDPXT04G01	4 mm	1/8" BSPP	10
CDPXT04G02	4 mm	1/4" BSPP	10
CDPXT06G01	6 mm	1/8" BSPP	5
CDPXT06G02	6 mm	1/4" BSPP	5



**SWIVEL BANJO  
METRIC MALE**

3700

PART NUMBER	TUBE OD	THREAD	BAG QTY
CDPH04M5N	4 mm	M5 x 0.8	10
CDPH04M6N	4 mm	M6 x 1.0	10
CDPH06M5N	6 mm	M5 x 0.8	10
CDPH06M6N	6 mm	M6 x 1.0	10



**SWIVEL BANJO  
BSPP MALE**

3700

PART NUMBER	TUBE OD	THREAD	BAG QTY
CDPH04G01	4 mm	1/8" BSPP	10
CDPH04G02	4 mm	1/4" BSPP	10
CDPH06G01	6 mm	1/8" BSPP	10
CDPH06G02	6 mm	1/4" BSPP	10
CDPH06G03	6 mm	3/8" BSPP	5
CDPH08G01	8 mm	1/8" BSPP	10
CDPH08G02	8 mm	1/4" BSPP	10
CDPH08G03	8 mm	3/8" BSPP	5
CDPH08G04	8 mm	1/2" BSPP	5
CDPH10G02	10 mm	1/4" BSPP	5
CDPH10G03	10 mm	3/8" BSPP	5
CDPH10G04	10 mm	1/2" BSPP	5
CDPH12G03	12 mm	3/8" BSPP	5
CDPH12G04	12 mm	1/2" BSPP	5

**BSPT MALE**

CDPH0401N	4 mm	1/8" BSPT	10
CDPH0402N	4 mm	1/4" BSPT	10
CDPH0601N	6 mm	1/8" BSPT	10
CDPH0602N	6 mm	1/4" BSPT	10
CDPH0603N	6 mm	3/8" BSPT	5
CDPH0801N	8 mm	1/8" BSPT	10
CDPH0802N	8 mm	1/4" BSPT	10
CDPH0803N	8 mm	3/8" BSPT	5
CDPH0804N	8 mm	1/2" BSPT	5
CDPH1001N	10 mm	1/8" BSPT	5
CDPH1002N	10 mm	1/4" BSPT	5
CDPH1003N	10 mm	3/8" BSPT	5
CDPH1004N	10 mm	1/2" BSPT	5
CDPH1202N	12 mm	1/4" BSPT	5
CDPH1203N	12 mm	3/8" BSPT	5
CDPH1204N	12 mm	1/2" BSPT	5



**STACKING BANJO  
BSPP MALE / BSPP FEMALE**

3700

PART NUMBER	TUBE OD	THREAD	BAG QTY
CDPHF04G01	4 mm	1/8" BSPP	10
CDPHF04G02	4 mm	1/4" BSPP	10
CDPHF04G03	4 mm	3/8" BSPP	5
CDPHF04G04	4 mm	1/2" BSPP	5
CDPHF06G01	6 mm	1/8" BSPP	10
CDPHF06G02	6 mm	1/4" BSPP	10
CDPHF06G03	6 mm	3/8" BSPP	5
CDPHF06G04	6 mm	1/2" BSPP	5
CDPHF08G01	8 mm	1/8" BSPP	10
CDPHF08G02	8 mm	1/4" BSPP	10
CDPHF08G03	8 mm	3/8" BSPP	5
CDPHF08G04	8 mm	1/2" BSPP	5
CDPHF10G01	10 mm	1/8" BSPP	5
CDPHF10G02	10 mm	1/4" BSPP	5
CDPHF10G03	10 mm	3/8" BSPP	5
CDPHF10G04	10 mm	1/2" BSPP	5
CDPHF12G02	12 mm	1/4" BSPP	5
CDPHF12G03	12 mm	3/8" BSPP	5
CDPHF12G04	12 mm	1/2" BSPP	5



**SWIVEL STACKING BANJO  
METRIC MALE / METRIC FEMALE**

3700

PART NUMBER	TUBE OD	THREAD	BAG QTY
CDPHF04M5N	4 mm	M5 x 0.8	10
CDPHF04M6N	4 mm	M6 x 1.0	10
CDPHF06M5N	6 mm	M5 x 0.8	10
CDPHF06M6N	6 mm	M6 x 1.0	10

**BSPT MALE / BSPT FEMALE**

CDPHF0401N	4 mm	1/8" BSPT	10
CDPHF0601N	6 mm	1/8" BSPT	10
CDPHF0602N	6 mm	1/4" BSPT	10
CDPHF0801N	8 mm	1/8" BSPT	10
CDPHF0802N	8 mm	1/4" BSPT	10
CDPHF0803N	8 mm	3/8" BSPT	5
CDPHF0804N	8 mm	1/2" BSPT	5
CDPHF1002N	10 mm	1/4" BSPT	5
CDPHF1003N	10 mm	3/8" BSPT	5
CDPHF1004N	10 mm	1/2" BSPT	5
CDPHF1203N	12 mm	3/8" BSPT	5
CDPHF1204N	12 mm	1/2" BSPT	5



## TUBE TO THREAD

### DOUBLE UNIVERSAL ELBOW BSPT MALE



3700

PART NUMBER	TUBE OD	THREAD	BAG QTY
CDPHL0401-2	4 mm	1/8" BSPT	5
CDPHL0402-2	4 mm	1/4" BSPT	5
CDPHL0403-2	4 mm	3/8" BSPT	5
CDPHL0404-2	4 mm	1/2" BSPT	4
CDPHL0601-2	6 mm	1/8" BSPT	5
CDPHL0602-2	6 mm	1/4" BSPT	5
CDPHL0603-2	6 mm	3/8" BSPT	5
CDPHL0604-2	6 mm	1/2" BSPT	4
CDPHL0801-2	8 mm	1/8" BSPT	5
CDPHL0802-2	8 mm	1/4" BSPT	5
CDPHL0803-2	8 mm	3/8" BSPT	5
CDPHL0804-2	8 mm	1/2" BSPT	4
CDPHL1001-2	10 mm	1/8" BSPT	5
CDPHL1002-2	10 mm	1/4" BSPT	5
CDPHL1003-2	10 mm	3/8" BSPT	5
CDPHL1004-2	10 mm	1/2" BSPT	4
CDPHL1202-2	12 mm	1/4" BSPT	3
CDPHL1203-2	12 mm	3/8" BSPT	3
CDPHL1204-2	12 mm	1/2" BSPT	3

### DOUBLE UNIVERSAL ELBOW BSPP MALE



3700

PART NUMBER	TUBE OD	THREAD	BAG QTY
CDPHL04G012	4 mm	1/8" BSPP	5
CDPHL04G022	4 mm	1/4" BSPP	5
CDPHL04G032	4 mm	3/8" BSPP	5
CDPHL04G042	4 mm	1/2" BSPP	4
CDPHL06G012	6 mm	1/8" BSPP	5
CDPHL06G022	6 mm	1/4" BSPP	5
CDPHL06G032	6 mm	3/8" BSPP	5
CDPHL06G042	6 mm	1/2" BSPP	4
CDPHL08G012	8 mm	1/8" BSPP	5
CDPHL08G022	8 mm	1/4" BSPP	5
CDPHL08G032	8 mm	3/8" BSPP	5
CDPHL08G042	8 mm	1/2" BSPP	4
CDPHL10G012	10 mm	1/8" BSPP	5
CDPHL10G022	10 mm	1/4" BSPP	5
CDPHL10G032	10 mm	3/8" BSPP	5
CDPHL10G042	10 mm	1/2" BSPP	4
CDPHL12G022	12 mm	1/4" BSPP	3
CDPHL12G032	12 mm	3/8" BSPP	3
CDPHL12G042	12 mm	1/2" BSPP	3

### TRIPLE UNIVERSAL ELBOW BSPT MALE



3700

PART NUMBER	TUBE OD	THREAD	BAG QTY
CDPHL0401-3	4 mm	1/8" BSPT	5
CDPHL0402-3	4 mm	1/4" BSPT	5
CDPHL0403-3	4 mm	3/8" BSPT	5
CDPHL0404-3	4 mm	1/2" BSPT	3
CDPHL0601-3	6 mm	1/8" BSPT	5
CDPHL0602-3	6 mm	1/4" BSPT	5
CDPHL0603-3	6 mm	3/8" BSPT	5
CDPHL0604-3	6 mm	1/2" BSPT	3
CDPHL0801-3	8 mm	1/8" BSPT	5
CDPHL0802-3	8 mm	1/4" BSPT	5
CDPHL0803-3	8 mm	3/8" BSPT	5
CDPHL0804-3	8 mm	1/2" BSPT	3
CDPHL1001-3	10 mm	1/8" BSPT	3
CDPHL1002-3	10 mm	1/4" BSPT	3
CDPHL1003-3	10 mm	3/8" BSPT	3
CDPHL1004-3	10 mm	1/2" BSPT	3
CDPHL1202-3	12 mm	1/4" BSPT	2
CDPHL1203-3	12 mm	3/8" BSPT	2
CDPHL1204-3	12 mm	1/2" BSPT	2

### TRIPLE UNIVERSAL ELBOW BSPP MALE



3700

PART NUMBER	TUBE OD	THREAD	BAG QTY
CDPHL04G013	4 mm	1/8" BSPP	5
CDPHL04G023	4 mm	1/4" BSPP	5
CDPHL04G033	4 mm	3/8" BSPP	5
CDPHL04G043	4 mm	1/2" BSPP	3
CDPHL06G013	6 mm	1/8" BSPP	5
CDPHL06G023	6 mm	1/4" BSPP	5
CDPHL06G033	6 mm	3/8" BSPP	5
CDPHL06G043	6 mm	1/2" BSPP	3
CDPHL08G013	8 mm	1/8" BSPP	5
CDPHL08G023	8 mm	1/4" BSPP	5
CDPHL08G033	8 mm	3/8" BSPP	5
CDPHL08G043	8 mm	1/2" BSPP	3
CDPHL10G013	10 mm	1/8" BSPP	3
CDPHL10G023	10 mm	1/4" BSPP	3
CDPHL10G033	10 mm	3/8" BSPP	3
CDPHL10G043	10 mm	1/2" BSPP	3
CDPHL12G023	12 mm	1/4" BSPP	2
CDPHL12G033	12 mm	3/8" BSPP	2
CDPHL12G043	12 mm	1/2" BSPP	2

### REDUCING TRIPLE BRANCH TEE BSPT MALE



3700

PART NUMBER	TUBE OD	TUBE OD	THREAD	BAG QTY
	A	B		
CDPKD06041	6 mm	4 mm	1/8" BSPT	5
CDPKD08042	8 mm	4 mm	1/4" BSPT	5
CDPKD08062	8 mm	6 mm	1/4" BSPT	5
CDPKD10083	10 mm	8 mm	3/8" BSPT	5

### REDUCING TRIPLE BRANCH TEE BSPP MALE



3700

PART NUMBER	TUBE OD	TUBE OD	THREAD	BAG QTY
	A	B		
CDPKD0604G1	6 mm	4 mm	1/8" BSPP	5
CDPKD0804G2	8 mm	4 mm	1/4" BSPP	5
CDPKD0806G2	8 mm	6 mm	1/4" BSPP	5
CDPKD1006G3	10 mm	6 mm	3/8" BSPP	5
CDPKD1008G3	10 mm	8 mm	3/8" BSPP	5

TUBE TO THREAD



3700



3700

SINGLE UNIVERSAL TEE  
BSPT MALE

SINGLE UNIVERSAL TEE  
BSPP MALE

PART NUMBER	TUBE OD	THREAD	BAG QTY
CDPHT0401-1	4 mm	1/8" BSPT	5
CDPHT0402-1	4 mm	1/4" BSPT	5
CDPHT0403-1	4 mm	3/8" BSPT	5
CDPHT0404-1	4 mm	1/2" BSPT	5
CDPHT0601-1	6 mm	1/8" BSPT	5
CDPHT0602-1	6 mm	1/4" BSPT	5
CDPHT0603-1	6 mm	3/8" BSPT	5
CDPHT0604-1	6 mm	1/2" BSPT	5
CDPHT0801-1	8 mm	1/8" BSPT	5
CDPHT0802-1	8 mm	1/4" BSPT	5
CDPHT0803-1	8 mm	3/8" BSPT	5
CDPHT0804-1	8 mm	1/2" BSPT	5
CDPHT1001-1	10 mm	1/8" BSPT	5
CDPHT1002-1	10 mm	1/4" BSPT	5
CDPHT1003-1	10 mm	3/8" BSPT	5
CDPHT1004-1	10 mm	1/2" BSPT	5
CDPHT1202-1	12 mm	1/4" BSPT	5
CDPHT1203-1	12 mm	3/8" BSPT	5
CDPHT1204-1	12 mm	1/2" BSPT	5

PART NUMBER	TUBE OD	THREAD	BAG QTY
CDPHT04G11	4 mm	1/8" BSPP	5
CDPHT04G21	4 mm	1/4" BSPP	5
CDPHT04G31	4 mm	3/8" BSPP	5
CDPHT04G41	4 mm	1/2" BSPP	5
CDPHT06G11	6 mm	1/8" BSPP	5
CDPHT06G21	6 mm	1/4" BSPP	5
CDPHT06G31	6 mm	3/8" BSPP	5
CDPHT06G41	6 mm	1/2" BSPP	5
CDPHT08G11	8 mm	1/8" BSPP	5
CDPHT08G21	8 mm	1/4" BSPP	5
CDPHT08G31	8 mm	3/8" BSPP	5
CDPHT08G41	8 mm	1/2" BSPP	5
CDPHT10G11	10 mm	1/8" BSPP	5
CDPHT10G21	10 mm	1/4" BSPP	5
CDPHT10G31	10 mm	3/8" BSPP	5
CDPHT10G41	10 mm	1/2" BSPP	5
CDPHT12G21	12 mm	1/4" BSPP	5
CDPHT12G31	12 mm	3/8" BSPP	5
CDPHT12G41	12 mm	1/2" BSPP	5



3700



3700

DOUBLE UNIVERSAL TEE  
BSPT MALE

DOUBLE UNIVERSAL TEE  
BSPP MALE

PART NUMBER	TUBE OD	THREAD	BAG QTY
CDPHT0401-2	4 mm	1/8" BSPT	5
CDPHT0402-2	4 mm	1/4" BSPT	5
CDPHT0403-2	4 mm	3/8" BSPT	5
CDPHT0404-2	4 mm	1/2" BSPT	5
CDPHT0601-2	6 mm	1/8" BSPT	5
CDPHT0602-2	6 mm	1/4" BSPT	5
CDPHT0603-2	6 mm	3/8" BSPT	4
CDPHT0604-2	6 mm	1/2" BSPT	3
CDPHT0801-2	8 mm	1/8" BSPT	4
CDPHT0802-2	8 mm	1/4" BSPT	4
CDPHT0803-2	8 mm	3/8" BSPT	4
CDPHT0804-2	8 mm	1/2" BSPT	3
CDPHT1001-2	10 mm	1/8" BSPT	3
CDPHT1002-2	10 mm	1/4" BSPT	3
CDPHT1003-2	10 mm	3/8" BSPT	3
CDPHT1004-2	10 mm	1/2" BSPT	3
CDPHT1202-2	12 mm	1/4" BSPT	3
CDPHT1203-2	12 mm	3/8" BSPT	3
CDPHT1204-2	12 mm	1/2" BSPT	2

PART NUMBER	TUBE OD	THREAD	BAG QTY
CDPHT04G12	4 mm	1/8" BSPP	5
CDPHT04G22	4 mm	1/4" BSPP	5
CDPHT04G32	4 mm	3/8" BSPP	4
CDPHT04G42	4 mm	1/2" BSPP	3
CDPHT06G12	6 mm	1/8" BSPP	5
CDPHT06G22	6 mm	1/4" BSPP	5
CDPHT06G32	6 mm	3/8" BSPP	4
CDPHT06G42	6 mm	1/2" BSPP	3
CDPHT08G12	8 mm	1/8" BSPP	4
CDPHT08G22	8 mm	1/4" BSPP	4
CDPHT08G32	8 mm	3/8" BSPP	4
CDPHT08G42	8 mm	1/2" BSPP	3
CDPHT10G12	10 mm	1/8" BSPP	3
CDPHT10G22	10 mm	1/4" BSPP	3
CDPHT10G32	10 mm	3/8" BSPP	3
CDPHT10G42	10 mm	1/2" BSPP	3
CDPHT12G22	12 mm	1/4" BSPP	3
CDPHT12G32	12 mm	3/8" BSPP	3
CDPHT12G42	12 mm	1/2" BSPP	2

TUBE TO THREAD



TRIPLE UNIVERSAL TEE  
BSPT MALE

3700

PART NUMBER	TUBE OD	THREAD	BAG QTY
CDPHT0401-3	4 mm	1/8" BSPT	5
CDPHT0402-3	4 mm	1/4" BSPT	5
CDPHT0403-3	4 mm	3/8" BSPT	3
CDPHT0404-3	4 mm	1/2" BSPT	3
CDPHT0601-3	6 mm	1/8" BSPT	3
CDPHT0602-3	6 mm	1/4" BSPT	3
CDPHT0603-3	6 mm	3/8" BSPT	3
CDPHT0604-3	6 mm	1/2" BSPT	3
CDPHT0801-3	8 mm	1/8" BSPT	3
CDPHT0802-3	8 mm	1/4" BSPT	3
CDPHT0803-3	8 mm	3/8" BSPT	3
CDPHT0804-3	8 mm	1/2" BSPT	2
CDPHT1001-3	10 mm	1/8" BSPT	2
CDPHT1002-3	10 mm	1/4" BSPT	2
CDPHT1003-3	10 mm	3/8" BSPT	2
CDPHT1004-3	10 mm	1/2" BSPT	2
CDPHT1202-3	12 mm	1/4" BSPT	2
CDPHT1203-3	12 mm	3/8" BSPT	2
CDPHT1204-3	12 mm	1/2" BSPT	2



TRIPLE UNIVERSAL TEE  
BSPP MALE

3700

PART NUMBER	TUBE OD	THREAD	BAG QTY
CDPHT04G13	4 mm	1/8" BSPP	5
CDPHT04G23	4 mm	1/4" BSPP	5
CDPHT04G33	4 mm	3/8" BSPP	3
CDPHT04G43	4 mm	1/2" BSPP	3
CDPHT06G13	6 mm	1/8" BSPP	3
CDPHT06G23	6 mm	1/4" BSPP	3
CDPHT06G33	6 mm	3/8" BSPP	3
CDPHT06G43	6 mm	1/2" BSPP	3
CDPHT08G13	8 mm	1/8" BSPP	3
CDPHT08G23	8 mm	1/4" BSPP	3
CDPHT08G33	8 mm	3/8" BSPP	3
CDPHT08G43	8 mm	1/2" BSPP	2
CDPHT10G13	10 mm	1/8" BSPP	2
CDPHT10G23	10 mm	1/4" BSPP	2
CDPHT10G33	10 mm	3/8" BSPP	2
CDPHT10G43	10 mm	1/2" BSPP	2
CDPHT12G23	12 mm	1/4" BSPP	2
CDPHT12G33	12 mm	3/8" BSPP	2
CDPHT12G43	12 mm	1/2" BSPP	2

Eight



DUAL BANJO  
BSPT MALE

3700

PART NUMBER	TUBE OD	THREAD	BAG QTY
CDPA0601	6 mm	1/8" BSPT	5
CDPA0802	8 mm	1/4" BSPT	5
CDPA1002	10 mm	1/4" BSPT	5
CDPA1003	10 mm	3/8" BSPT	5
CDPA1203	12 mm	3/8" BSPT	4
CDPA1204	12 mm	1/2" BSPT	4



DUAL BANJO  
METRIC MALE

3700

PART NUMBER	TUBE OD	THREAD	BAG QTY
CDPA04M5	4 mm	M5 x 0.8	10

BSPP MALE			
PART NUMBER	TUBE OD	THREAD	BAG QTY
CDPA06G01	6 mm	1/8" BSPP	5
CDPA08G02	8 mm	1/4" BSPP	5
CDPA10G02	10 mm	1/4" BSPP	5
CDPA10G03	10 mm	3/8" BSPP	5
CDPA12G03	12 mm	3/8" BSPP	4
CDPA12G04	12 mm	1/2" BSPP	4



DUAL STACKING BANJO  
BSPT MALE / BSPT FEMALE

3700

PART NUMBER	TUBE OD	THREAD	BAG QTY
CDPAF0601	6 mm	1/8" BSPT	5
CDPAF0802	8 mm	1/4" BSPT	5
CDPAF1002	10 mm	1/4" BSPT	5
CDPAF1003	10 mm	3/8" BSPT	5
CDPAF1203	12 mm	3/8" BSPT	4
CDPAF1204	12 mm	1/2" BSPT	4



DUAL STACKING BANJO  
METRIC MALE / METRIC FEMALE

3700

PART NUMBER	TUBE OD	THREAD	BAG QTY
CDPAF04M5	4 mm	M5 x 0.8	10

BSPP MALE / BSPP FEMALE			
PART NUMBER	TUBE OD	THREAD	BAG QTY
CDPAF06G01	6 mm	1/8" BSPP	5
CDPAF08G02	8 mm	1/4" BSPP	5
CDPAF10G02	10 mm	1/4" BSPP	5
CDPAF10G03	10 mm	3/8" BSPP	5
CDPAF12G03	12 mm	3/8" BSPP	4
CDPAF12G04	12 mm	1/2" BSPP	4

TUBE TO THREAD



DOUBLE BRANCH BANJO  
BSPT MALE

3700

PART NUMBER	TUBE OD	THREAD	BAG QTY
CDPAT04012	4 mm	1/8" BSPT	5
CDPAT04022	4 mm	1/4" BSPT	5
CDPAT04032	4 mm	3/8" BSPT	4
CDPAT04042	4 mm	1/2" BSPT	3
CDPAT06012	6 mm	1/8" BSPT	5
CDPAT06022	6 mm	1/4" BSPT	4
CDPAT06032	6 mm	3/8" BSPT	4
CDPAT06042	6 mm	1/2" BSPT	3
CDPAT08012	8 mm	1/8" BSPT	4
CDPAT08022	8 mm	1/4" BSPT	4
CDPAT08032	8 mm	3/8" BSPT	3
CDPAT08042	8 mm	1/2" BSPT	3
CDPAT10022	10 mm	1/4" BSPT	3
CDPAT10032	10 mm	3/8" BSPT	3
CDPAT10042	10 mm	1/2" BSPT	2
CDPAT12022	12 mm	1/4" BSPT	3
CDPAT12032	12 mm	3/8" BSPT	2
CDPAT12042	12 mm	1/2" BSPT	1



DOUBLE BRANCH BANJO  
BSPP MALE

3700

PART NUMBER	TUBE OD	THREAD	BAG QTY
CDPAT04G012	4 mm	1/8" BSPP	5
CDPAT04G022	4 mm	1/4" BSPP	5
CDPAT04G032	4 mm	3/8" BSPP	4
CDPAT04G042	4 mm	1/2" BSPP	3
CDPAT06G012	6 mm	1/8" BSPP	5
CDPAT06G022	6 mm	1/4" BSPP	4
CDPAT06G032	6 mm	3/8" BSPP	3
CDPAT06G042	6 mm	1/2" BSPP	2
CDPAT08G012	8 mm	1/8" BSPP	4
CDPAT08G022	8 mm	1/4" BSPP	4
CDPAT08G032	8 mm	3/8" BSPP	3
CDPAT08G042	8 mm	1/2" BSPP	3
CDPAT10G022	10 mm	1/4" BSPP	3
CDPAT10G032	10 mm	3/8" BSPP	3
CDPAT10G042	10 mm	1/2" BSPP	2
CDPAT12G022	12 mm	1/4" BSPP	3
CDPAT12G032	12 mm	3/8" BSPP	2
CDPAT12G042	12 mm	1/2" BSPP	1



TRIPLE BRANCH BANJO  
BSPT MALE

3700

PART NUMBER	TUBE OD	THREAD	BAG QTY
CDPAT04013	4 mm	1/8" BSPT	5
CDPAT04023	4 mm	1/4" BSPT	5
CDPAT04033	4 mm	3/8" BSPT	3
CDPAT04043	4 mm	1/2" BSPT	2
CDPAT06013	6 mm	1/8" BSPT	4
CDPAT06023	6 mm	1/4" BSPT	4
CDPAT06033	6 mm	3/8" BSPT	3
CDPAT06043	6 mm	1/2" BSPT	2
CDPAT08013	8 mm	1/8" BSPT	3
CDPAT08023	8 mm	1/4" BSPT	3
CDPAT08033	8 mm	3/8" BSPT	2
CDPAT08043	8 mm	1/2" BSPT	2
CDPAT10023	10 mm	1/4" BSPT	2
CDPAT10033	10 mm	3/8" BSPT	2
CDPAT10043	10 mm	1/2" BSPT	2
CDPAT12023	12 mm	1/4" BSPT	2
CDPAT12033	12 mm	3/8" BSPT	1
CDPAT12043	12 mm	1/2" BSPT	1



TRIPLE BRANCH BANJO  
BSPP MALE

3700

PART NUMBER	TUBE OD	THREAD	BAG QTY
CDPAT04G013	4 mm	1/8" BSPP	5
CDPAT04G023	4 mm	1/4" BSPP	5
CDPAT04G033	4 mm	3/8" BSPP	2
CDPAT04G043	4 mm	1/2" BSPP	2
CDPAT06G013	6 mm	1/8" BSPP	4
CDPAT06G023	6 mm	1/4" BSPP	4
CDPAT06G033	6 mm	3/8" BSPP	3
CDPAT06G043	6 mm	1/2" BSPP	2
CDPAT08G013	8 mm	1/8" BSPP	3
CDPAT08G023	8 mm	1/4" BSPP	3
CDPAT08G033	8 mm	3/8" BSPP	2
CDPAT08G043	8 mm	1/2" BSPP	2
CDPAT12G023	12 mm	1/4" BSPP	2
CDPAT12G033	12 mm	3/8" BSPP	1
CDPAT12G043	12 mm	1/2" BSPP	1

Eight

Do you also need?

**Fluidfit  
push-in fittings**

Find it on pages 528 – 536, section eight

METRIC TUBE TO TUBE



REDUCER TRIPLE BRANCH UNION

3700

PART NUMBER	TUBE OD A	TUBE OD B	BAG QTY
CDPKG0604N	6 mm	4 mm	5
CDPKG0804N	8 mm	4 mm	5
CDPKG0806N	8 mm	6 mm	5
CDPKG1006N	10 mm	6 mm	5
CDPKG1008N	10 mm	8 mm	5



PLUG-IN REDUCER TRIPLE BRANCH UNION

3700

PART NUMBER	TUBE OD		STEM OD	BAG QTY
	A	B	C	
CDPKJ0604N	6 mm	4 mm	6 mm	5
CDPKJ0804N	8 mm	4 mm	8 mm	5
CDPKJ0806N	8 mm	6 mm	8 mm	5
CDPKJ1006N	10 mm	6 mm	10 mm	5
CDPKJ1008N	10 mm	8 mm	10 mm	5



PLUG

3700

PART NUMBER	TUBE OD	BAG QTY
CDPP04N	4 mm	10
CDPP06N	6 mm	10
CDPP08N	8 mm	10
CDPP10N	10 mm	10
CDPP12N	12 mm	10
CDPP16N	16 mm	10



DOUBLE UNION Y REDUCER

3700

PART NUMBER	TUBE OD A	TUBE OD B	BAG QTY
CDPXG0604N	6 mm	4 mm	10
CDPXG0806N	8 mm	6 mm	5



BULKHEAD UNION ELBOW

3700

PART NUMBER	TUBE OD	BAG QTY
CDPLM04N	4 mm	10
CDPLM06N	6 mm	10
CDPLM08N	8 mm	10
CDPLM10N	10 mm	5
CDPLM12N	12 mm	5



PLASTIC BULKHEAD UNION

3700

PART NUMBER	TUBE OD	BAG QTY
CDPMP04N	4 mm	10
CDPMP06N	6 mm	10
CDPMP08N	8 mm	10
CDPMP10N	10 mm	5
CDPMP12N	12 mm	5



CARTRIDGE

3700

PART NUMBER	TUBE OD	HOLE ID	BAG QTY
CDCAS04	4 mm	8.95 mm	10
CDCAS06	6 mm	11.10 mm	10
CDCAS08	8 mm	13.20 mm	10
CDCAS10	10 mm	15.45 mm	10
CDCAS12	12 mm	17.75 mm	10

Please contact your distributor for drilling dimensions

## METRIC TUBE TO TUBE

### PLUG-IN ELBOW



3700

PART NUMBER	STEM OD	TUBE OD	BAG QTY
CDPLJ04N	4 mm	4 mm	10
CDPLJ06N	6 mm	6 mm	10
CDPLJ08N	8 mm	8 mm	10
CDPLJ10N	10 mm	10 mm	10
CDPLJ12N	12 mm	12 mm	5
CDPLJ16N	16 mm	16 mm	5

### PLUG-IN REDUCER

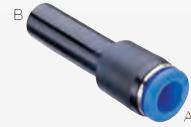

3700

PART NUMBER	STEM OD B	TUBE OD A	BAG QTY
CDPGJ0406N	4 mm	6 mm	10
CDPGJ0604N	6 mm	4 mm	10
CDPGJ0608N	6 mm	8 mm	10
CDPGJ0804N	8 mm	4 mm	10
CDPGJ0806N	8 mm	6 mm	10
CDPGJ1006N	10 mm	6 mm	10
CDPGJ1008N	10 mm	8 mm	10
CDPGJ1206N	12 mm	6 mm	10
CDPGJ1208N	12 mm	8 mm	10
CDPGJ1210N	12 mm	10 mm	10

### PLUG-IN Y



3700

PART NUMBER	STEM OD	TUBE OD	BAG QTY
CDPYJ04N	4 mm	4 mm	10
CDPYJ06N	6 mm	6 mm	10
CDPYJ08N	8 mm	8 mm	10
CDPYJ10N	10 mm	10 mm	5
CDPYJ12N	12 mm	12 mm	5

### PLUG-IN REDUCER Y



3700

PART NUMBER	STEM OD B	TUBE OD A	BAG QTY
CDPWJ0604N	6 mm	4 mm	10
CDPWJ0806N	8 mm	6 mm	10
CDPWJ1008N	10 mm	8 mm	10
CDPWJ1210N	12 mm	10 mm	5

### TUBE SPLICER



3700

PART NUMBER	STEM OD	BAG QTY
CDPIJ04	4 mm	10
CDPIJ06	6 mm	10
CDPIJ08	8 mm	10
CDPIJ10	10 mm	10
CDPIJ12	12 mm	10
CDPIJ16	16 mm	10

### REDUCER TUBE SPLICER



3700

PART NUMBER	STEM OD A	STEM OD B	BAG QTY
CDPIG0604	6 mm	4 mm	10
CDPIG0804	8 mm	4 mm	10
CDPIG0806	8 mm	6 mm	10
CDPIG1006	10 mm	6 mm	10
CDPIG1008	10 mm	8 mm	10
CDPIG1208	12 mm	8 mm	10
CDPIG1210	12 mm	10 mm	10
CDPIG1612	16 mm	12 mm	10

### PLUG-IN RUN TEE



3700

PART NUMBER	STEM OD A	TUBE OD B	BAG QTY
CDPSJ04N	4 mm	4 mm	10
CDPSJ0604N	6 mm	4 mm	10
CDPSJ06N	6 mm	6 mm	10
CDPSJ0806N	8 mm	6 mm	5
CDPSJ08N	8 mm	8 mm	5
CDPSJ1008N	10 mm	8 mm	5
CDPSJ10N	10 mm	10 mm	5
CDPSJ1210N	12 mm	10 mm	5
CDPSJ12N	12 mm	12 mm	5

### PLUG-IN BRANCH TEE



3700

PART NUMBER	STEM OD A	TUBE OD B	BAG QTY
CDPTJ04N	4 mm	4 mm	10
CDPTJ0604N	6 mm	4 mm	10
CDPTJ06N	6 mm	6 mm	10
CDPTJ0806N	8 mm	6 mm	10
CDPTJ08N	8 mm	8 mm	10
CDPTJ1008N	10 mm	8 mm	5
CDPTJ10N	10 mm	10 mm	5
CDPTJ1210N	12 mm	10 mm	5
CDPTJ12N	12 mm	12 mm	5



## PUSH-IN FITTING KITS

### 4 MM KIT



3700

PART NUMBER	DESCRIPTION
KIT-CDC04	4 mm push-in fitting kit

#### 4 MM KIT CONTENTS

3 x CDPJ04	Tube splicer	5 x CDPUL04N	Equal elbow
3 x CDP04N	Tube plug	5 x CDPUC04N	Equal straight
1 x D-TC14	Tube cutter	5 x CDPL0401N	Rotating male elbow
3 x CDP04N	Tube cap	5 x CDPL0402N	Rotating male elbow
5 x CDP04N	Equal tee	5 x CDPC0401N	Male stud coupling
5 x CDPY04N	Equal Y	5 x CDPC0402N	Male stud coupling
3 x CDPG0604N	Reducer		

### 6 MM KIT

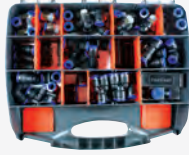

3700

PART NUMBER	DESCRIPTION
KIT-CDC06	6 mm push-in fitting kit

#### 6 MM KIT CONTENTS

5 x CDPJ06	Tube splicer	5 x CDPUL06N	Equal elbow
3 x CDP06N	Tube plug	5 x CDPUC06N	Equal straight
1 x D-TC14	Tube cutter	5 x CDPL0601N	Rotating male elbow
3 x CDP06N	Tube cap	5 x CDPL0602N	Rotating male elbow
5 x CDP06N	Equal tee	5 x CDPC0601N	Male stud coupling
5 x CDPY06N	Equal Y	5 x CDPC0602N	Male stud coupling
3 x CDPG0604N	Reducer	1 x CDHUU0606	Straight valve
3 x CDPG0806N	Reducer		

### 8 MM KIT

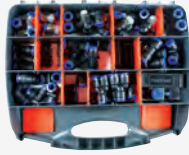

3700

PART NUMBER	DESCRIPTION
KIT-CDC08	8 mm push-in fitting kit

#### 8 MM KIT CONTENTS

5 x CDPJ08	Tube splicer	5 x CDPUL08N	Equal elbow
3 x CDP08N	Tube plug	5 x CDPUC08N	Equal straight
1 x D-TC14	Tube cutter	5 x CDPL0802N	Rotating male elbow
3 x CDP08N	Tube cap	5 x CDPL0803N	Rotating male elbow
5 x CDP08N	Equal tee	5 x CDPC0802N	Male stud coupling
5 x CDPY08N	Equal Y	5 x CDPC0803N	Male stud coupling
3 x CDPG0806N	Reducer	1 x CDHUU0808	Straight valve
3 x CDPG1008N	Reducer		

### 10 MM KIT



3700

PART NUMBER	DESCRIPTION
KIT-CDC10	10 mm push-in fitting kit

#### 10 MM KIT CONTENTS

5 x CDPJ10	Tube splicer	5 x CDPUL10N	Equal tee
3 x CDP10N	Tube plug	5 x CDPUC10N	Equal straight
1 x D-TC14	Tube cutter	5 x CDPL1002N	Rotating male elbow
3 x CDP10N	Tube cap	5 x CDPL1003N	Rotating male elbow
5 x CDPY10N	Equal Y	5 x CDPC1002N	Male stud coupling
3 x CDPG1008N	Reducer	5 x CDPC1003N	Male stud coupling
3 x CDPG1210N	Reducer	1 x CDHUU1010	Straight valve
5 x CDPUL10N	Equal elbow		

### 12 MM KIT



3700

PART NUMBER	DESCRIPTION
KIT-CDC12	12 mm push-in fitting kit

#### 12 MM KIT CONTENTS

5 x CDPJ12	Tube splicer	5 x CDPUL12N	Equal elbow
3 x CDP12N	Tube plug	5 x CDPUC12N	Equal straight
1 x D-TC14	Tube cutter	5 x CDPL1203N	Rotating male elbow
3 x CDP12N	Tube cap	5 x CDPL1204N	Rotating male elbow
3 x CDP12N	Equal tee	5 x CDPC1203N	Male stud coupling
3 x CDPY12N	Equal Y	5 x CDPC1204N	Male stud coupling
3 x CDPG1210N	Reducer	1 x CDHUU1212	Straight valve

### MIX KIT



3700

PART NUMBER	DESCRIPTION
KIT-MIXCDC060810	Mixed size push-in fitting kit

#### MIX KIT CONTENTS

5 x CDP06N	Equal tee	4 x CDPMM08N	Bulkhead union
5 x CDP08N	Equal tee	3 x CDPMM10N	Bulkhead union
3 x CDP10N	Equal tee	5 x CDPL0803N	Rotating male elbow
5 x CDPUL06N	Equal elbow	2 x CDPL1004N	Rotating male elbow
5 x CDPUL08N	Equal elbow	5 x CDPC0601N	Male stud coupling
3 x CDPUL10N	Equal elbow	5 x CDPC0602N	Male stud coupling
1 x D-TC14	Tube cutter	5 x CDPC0802N	Male stud coupling
5 x CDP06N	Tube plug	5 x CDPC0803N	Male stud coupling
4 x CDP08N	Tube plug	5 x CDPL0601N	Rotating male elbow
5 x CDP10N	Tube plug	5 x CDPL0602N	Rotating male elbow
5 x CDPGJ0806N	Reducer	3 x CDPC1002N	Male stud coupling
5 x CDPGJ1008N	Reducer	3 x CDPC1003N	Male stud coupling
3 x CDP06N	Tube cap	3 x CDPC1004N	Male stud coupling
3 x CDP08N	Tube cap	5 x CDPL0802N	Rotating male elbow
2 x CDP06N	Tube cap	3 x CDPL1003N	Rotating male elbow
5 x CDPMM06N	Bulkhead union		

IMPERIAL TUBE TO TUBE



EQUAL STRAIGHT UNION

3700

PART NUMBER	TUBE OD	BAG QTY
CDPUC5/32	5/32"	10
CDPUC3/16	3/16"	10
CDPUC1/4	1/4"	10
CDPUC5/16	5/16"	10
CDPUC3/8	3/8"	10
CDPUC1/2	1/2"	5



REDUCER TEE

3700

PART NUMBER	TUBE OD A	TUBE OD B	BAG QTY
CDPGT1/45/32	1/4"	5/32"	10
CDPGT5/161/4	5/16"	1/4"	10
CDPGT3/81/4	3/8"	1/4"	10
CDPGT3/85/16	3/8"	5/16"	10
CDPGT1/23/8	1/2"	3/8"	5



EQUAL UNION ELBOW

3700

PART NUMBER	TUBE OD	BAG QTY
CDPUL5/32	5/32"	10
CDPUL3/16	3/16"	10
CDPUL1/4	1/4"	10
CDPUL5/16	5/16"	10
CDPUL3/8	3/8"	10
CDPUL1/2	1/2"	5



UNION CROSS

3700

PART NUMBER	TUBE OD	BAG QTY
CDPZA5/32	5/32"	10
CDPZA3/16	3/16"	10
CDPZA1/4	1/4"	10
CDPZA5/16	5/16"	5
CDPZA3/8	3/8"	5
CDPZA1/2	1/2"	3



EQUAL UNION TEE

3700

PART NUMBER	TUBE OD	BAG QTY
CDPUT5/32	5/32"	10
CDPUT3/16	3/16"	10
CDPUT1/4	1/4"	10
CDPUT5/16	5/16"	10
CDPUT3/8	3/8"	5
CDPUT1/2	1/2"	5



BULKHEAD UNION

3700

PART NUMBER	TUBE OD	BAG QTY
CDPMM5/32N	5/32"	10
CDPMM3/16N	3/16"	10
CDPMM1/4N	1/4"	10
CDPMM5/16N	5/16"	10
CDPMM3/8N	3/8"	5
CDPMM1/2N	1/2"	5



REDUCER

3700

PART NUMBER	TUBE OD	TUBE OD	BAG QTY
CDPG3/165/32	3/16"	5/32"	10
CDPG1/45/32	1/4"	5/32"	10
CDPG1/43/16	1/4"	3/16"	10
CDPG5/161/4	5/16"	1/4"	10
CDPG3/81/4	3/8"	1/4"	10
CDPG3/85/16	3/8"	5/16"	10
CDPG1/23/8	1/2"	3/8"	5



CAP

3700

PART NUMBER	TUBE OD	BAG QTY
CDPPF5/32	5/32"	10
CDPPF3/16	3/16"	10
CDPPF1/4	1/4"	10
CDPPF5/16	5/16"	10
CDPPF3/8	3/8"	10
CDPPF1/2	1/2"	10



EQUAL UNION Y

3700

PART NUMBER	TUBE OD	BAG QTY
CDPY5/32	5/32"	10
CDPY3/16	3/16"	10
CDPY1/4	1/4"	10
CDPY5/16	5/16"	10
CDPY3/8	3/8"	5
CDPY1/2	1/2"	5



REDUCER Y

3700

PART NUMBER	TUBE OD A	TUBE OD B	BAG QTY
CDPW3/165/32	3/16"	5/32"	10
CDPW1/45/32	1/4"	5/32"	10
CDPW1/43/16	1/4"	3/16"	10
CDPW5/161/4	5/16"	1/4"	10
CDPW3/81/4	3/8"	1/4"	10
CDPW3/85/16	3/8"	5/16"	10
CDPW1/23/8	1/2"	3/8"	5

IMPERIAL TO THREAD BSPT

STRAIGHT  
BSPT MALE



PART NUMBER	TUBE OD	THREAD	BAG QTY
CDPC1/401	1/4"	1/8" BSPT	10
CDPC1/402	1/4"	1/4" BSPT	10
CDPC1/403	1/4"	3/8" BSPT	10
CDPC3/801	3/8"	1/8" BSPT	10
CDPC3/802	3/8"	1/4" BSPT	10
CDPC3/803	3/8"	3/8" BSPT	10
CDPC3/804	3/8"	1/2" BSPT	10
CDPC1/202	1/2"	1/4" BSPT	10
CDPC1/203	1/2"	3/8" BSPT	10
CDPC1/204	1/2"	1/2" BSPT	10

SWIVEL ELBOW  
BSPT MALE



PART NUMBER	TUBE OD	THREAD	BAG QTY
CDPL1/401	1/4"	1/8" BSPT	10
CDPL1/402	1/4"	1/4" BSPT	10
CDPL1/403	1/4"	3/8" BSPT	10
CDPL3/801	3/8"	1/8" BSPT	10
CDPL3/802	3/8"	1/4" BSPT	10
CDPL3/803	3/8"	3/8" BSPT	10
CDPL3/804	3/8"	1/2" BSPT	5
CDPL1/202	1/2"	1/4" BSPT	5
CDPL1/203	1/2"	3/8" BSPT	5
CDPL1/204	1/2"	1/2" BSPT	5

STRAIGHT  
BSPT FEMALE



PART NUMBER	TUBE OD	THREAD	BAG QTY
CDPCF1/401	1/4"	1/8" BSPT	10
CDPCF1/402	1/4"	1/4" BSPT	10
CDPCF3/802	3/8"	1/4" BSPT	10
CDPCF3/803	3/8"	3/8" BSPT	10

SWIVEL BRANCH TEE  
BSPT MALE



PART NUMBER	TUBE OD	THREAD	BAG QTY
CDPT1/401	1/4"	1/8" BSPT	10
CDPT1/402	1/4"	1/4" BSPT	10
CDPT1/403	1/4"	3/8" BSPT	10
CDPT3/801	3/8"	1/8" BSPT	5
CDPT3/802	3/8"	1/4" BSPT	5
CDPT3/803	3/8"	3/8" BSPT	5
CDPT3/804	3/8"	1/2" BSPT	5
CDPT1/202	1/2"	1/4" BSPT	5
CDPT1/203	1/2"	3/8" BSPT	5
CDPT1/204	1/2"	1/2" BSPT	5

IMPERIAL TUBE TO THREAD NPT

STRAIGHT  
NPT MALE



PART NUMBER	TUBE OD	THREAD	BAG QTY
CDPC1/4N02	1/4"	1/4" NPT	10
CDPC3/8N03	3/8"	3/8" NPT	10
CDPC1/2N04	1/2"	1/2" NPT	10

STRAIGHT  
NPT FEMALE



PART NUMBER	TUBE OD	THREAD	BAG QTY
CDPCF1/4N02	1/4"	1/4" NPT	10
CDPCF3/8N03	3/8"	3/8" NPT	10

SWIVEL ELBOW  
NPT MALE



PART NUMBER	TUBE OD	THREAD	BAG QTY
CDPL1/4N02	1/4"	1/4" NPT	10
CDPL3/8N03	3/8"	3/8" NPT	10
CDPL1/2N04	1/2"	1/2" NPT	5

SWIVEL BRANCH TEE  
NPT MALE



PART NUMBER	TUBE OD	THREAD	BAG QTY
CDPT1/4N02	1/4"	1/4" NPT	10
CDPT3/8N03	3/8"	3/8" NPT	5
CDPT1/2N04	1/2"	1/2" NPT	5

# CDC Compact One Touch 10 Bar Fittings

## Features

- One touch, push-to-connect configuration allows instant tubing connection
- Size and OD are smaller than the regular type, but the same flow is obtained
- Electroless nickel-coated surfaces for excellent tolerance to corrosion
- The oval sleeve is designed to allow easy release in limited spaces
- The screw section has an O-ring and Teflon™ coating
- Miniaturised fittings for small devices and piping in limited spaces

## Applications

- Mini one-touch type pipe connection tool for air pressure piping in limited spaces
- Various uses depending on the user's environment

## Specifications

Suitability	Air (no other type of gas or liquid) <b>Do not use in water applications</b>
Working pressure	0 to 150 psi (10.3 bar)
Negative pressure	-29.5 in Hg / -750 mm Hg (-750 Torr)
Working temperature	0°C to 60°C (32°F to 140°F)
Application tube	Polyurethane and nylon

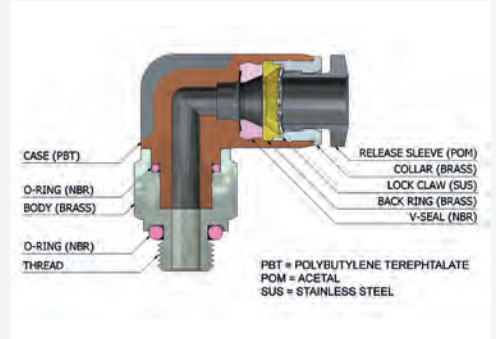

Eight

## METRIC TUBE TO THREAD



### STRAIGHT METRIC MALE

PART NUMBER	TUBE OD	THREAD	BAG QTY
CDPC-C03M3	3 mm	M3 x 0.5	10
CDPC-C03M5	3 mm	M5 x 0.8	10
CDPC-C03M6	3 mm	M6 x 1.0	10
CDPC-C04M3	4 mm	M3 x 0.5	10
CDPC-C04M5	4 mm	M5 x 0.8	10
CDPC-C04M6	4 mm	M6 x 1.0	10
CDPC-C06M5	6 mm	M5 x 0.8	10
CDPC-C06M6	6 mm	M6 x 1.0	10

### BSPT MALE

CDPC-C0401	4 mm	1/8" BSPT	10
CDPC-C0601	6 mm	1/8" BSPT	10



### ROUND STRAIGHT METRIC MALE

PART NUMBER	TUBE OD	THREAD	BAG QTY
CDPOC-C03M3	3 mm	M3 x 0.5	10
CDPOC-C03M5	3 mm	M5 x 0.8	10
CDPOC-C03M6	3 mm	M6 x 1.0	10
CDPOC-C04M3	4 mm	M3 x 0.5	10
CDPOC-C04M5	4 mm	M5 x 0.8	10
CDPOC-C04M6	4 mm	M6 x 1.0	10
CDPOC-C06M5	6 mm	M5 x 0.8	10
CDPOC-C06M6	6 mm	M6 x 1.0	10

### BSPT MALE

CDPOC-C0401	4 mm	1/8" BSPT	10
CDPOC-C0601	6 mm	1/8" BSPT	10

METRIC TUBE TO THREAD

STRAIGHT  
METRIC FEMALE



PART NUMBER	TUBE OD	THREAD	BAG QTY
CDPCF-C03M3	3 mm	M3 x 0.5	10
CDPCF-C03M5	3 mm	M5 x 0.8	10
CDPCF-C03M6	3 mm	M6 x 1.0	10
CDPCF-C04M3	4 mm	M3 x 0.5	10
CDPCF-C04M5	4 mm	M5 x 0.8	10
CDPCF-C04M6	4 mm	M6 x 1.0	10
CDPCF-C06M5	6 mm	M5 x 0.8	10
CDPCF-C06M6	6 mm	M6 x 1.0	10

BSPT FEMALE

CDPCF-C0401	4 mm	1/8" BSPT	10
CDPCF-C0601	6 mm	1/8" BSPT	10

SWIVEL BRANCH TEE  
METRIC MALE



PART NUMBER	TUBE OD	THREAD	BAG QTY
CDPT-C03M3	3 mm	M3 x 0.5	10
CDPT-C03M5	3 mm	M5 x 0.8	10
CDPT-C03M6	3 mm	M6 x 1.0	10
CDPT-C04M3	4 mm	M3 x 0.5	10
CDPT-C04M5	4 mm	M5 x 0.8	10
CDPT-C04M6	4 mm	M6 x 1.0	10
CDPT-C06M5	6 mm	M5 x 0.8	10
CDPT-C06M6	6 mm	M6 x 1.0	10

BSPT MALE

CDPT-C0401	4 mm	1/8" BSPT	10
CDPT-C0601	6 mm	1/8" BSPT	10

SWIVEL ELBOW  
METRIC MALE



PART NUMBER	TUBE OD	THREAD	BAG QTY
CDPL-C03M3	3 mm	M3 x 0.5	10
CDPL-C03M5	3 mm	M5 x 0.8	10
CDPL-C03M6	3 mm	M6 x 1.0	10
CDPL-C04M3	4 mm	M3 x 0.5	10
CDPL-C04M5	4 mm	M5 x 0.8	10
CDPL-C04M6	4 mm	M6 x 1.0	10
CDPL-C06M5	6 mm	M5 x 0.8	10
CDPL-C06M6	6 mm	M6 x 1.0	10

BSPT MALE

CDPL-C0401	4 mm	1/8" BSPT	10
CDPL-C0601	6 mm	1/8" BSPT	10

SWIVEL RUN TEE  
METRIC MALE



PART NUMBER	TUBE OD	THREAD	BAG QTY
CDPST-C03M3	3 mm	M3 x 0.5	10
CDPST-C03M5	3 mm	M5 x 0.8	10
CDPST-C03M6	3 mm	M6 x 1.0	10
CDPST-C04M3	4 mm	M3 x 0.5	10
CDPST-C04M5	4 mm	M5 x 0.8	10
CDPST-C04M6	4 mm	M6 x 1.0	10
CDPST-C06M5	6 mm	M5 x 0.8	10
CDPST-C06M6	6 mm	M6 x 1.0	10

BSPT MALE

CDPST-C0401	4 mm	1/8" BSPT	10
CDPST-C0601	6 mm	1/8" BSPT	10

SWIVEL EXTENDED ELBOW  
METRIC MALE



PART NUMBER	TUBE OD	THREAD	BAG QTY
CDPLL-C03M3	3 mm	M3 x 0.5	10
CDPLL-C03M5	3 mm	M5 x 0.8	10
CDPLL-C03M6	3 mm	M6 x 1.0	10
CDPLL-C04M3	4 mm	M3 x 0.5	10
CDPLL-C04M5	4 mm	M5 x 0.8	10
CDPLL-C04M6	4 mm	M6 x 1.0	10
CDPLL-C06M5	6 mm	M5 x 0.8	10
CDPLL-C06M6	6 mm	M6 x 1.0	10

BSPT MALE

CDPLL-C0401	4 mm	1/8" BSPT	10
CDPLL-C0601	6 mm	1/8" BSPT	10

SWIVEL ELBOW  
BSPP MALE



PART NUMBER	TUBE OD	THREAD	BAG QTY
CDPL-C04G01	4 mm	1/8" BSPP	10
CDPL-C06G01	6 mm	1/8" BSPP	10

STRAIGHT  
BSPP MALE



PART NUMBER	TUBE OD	THREAD	BAG QTY
CDPC-C04G01	4 mm	1/8" BSPP	10
CDPC-C06G01	6 mm	1/8" BSPP	10

METRIC TUBE TO TUBE



STRAIGHT UNION

3700

PART NUMBER	TUBE OD	BAG QTY
CDPUC-C03	3 mm	10
CDPUC-C04	4 mm	10
CDPUC-C06	6 mm	10



BULKHEAD UNION

3700

PART NUMBER	TUBE OD	BAG QTY
CDPMM-C03	3 mm	10
CDPMM-C04	4 mm	10
CDPMM-C06	6 mm	10



UNION ELBOW

3700

PART NUMBER	TUBE OD	BAG QTY
CDPUL-C03	3 mm	10
CDPUL-C04	4 mm	10
CDPUL-C06	6 mm	10



UNION TEE

3700

PART NUMBER	TUBE OD	BAG QTY
CDPUT-C03	3 mm	10
CDPUT-C04	4 mm	10
CDPUT-C06	6 mm	10

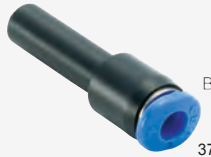

PLUG-IN REDUCER

3700

PART NUMBER	TUBE OD A	TUBE OD B	BAG QTY
CDPGJ-C0403	4 mm	3 mm	10
CDPGJ-C0603	6 mm	3 mm	10
CDPGJ-C0604	6 mm	4 mm	10



REDUCER

3700

PART NUMBER	TUBE OD A	TUBE OD B	BAG QTY
CDPG-C0403	4 mm	3 mm	10
CDPG-C0603	6 mm	3 mm	10
CDPG-C0604	6 mm	4 mm	10



UNION Y

3700

PART NUMBER	TUBE OD	BAG QTY
CDPY-C03	3 mm	10
CDPY-C04	4 mm	10
CDPY-C06	6 mm	10



REDUCER Y

3700

PART NUMBER	TUBE OD A	TUBE OD B	BAG QTY
CDPW-C0403	4 mm	3 mm	10
CDPW-C0603	6 mm	3 mm	10
CDPW-C0604	6 mm	4 mm	10



PLUG

3700

PART NUMBER	TUBE OD	BAG QTY
CDPP-C03	3 mm	10



## CDC 10 Bar Stop Fittings

### Features

- Air is completely blocked when the tube is released, and the air flows again only after connection, to ensure safety. The air flows only when the tube is connected.

### Applications

- Used where pneumatic piping frequently changes

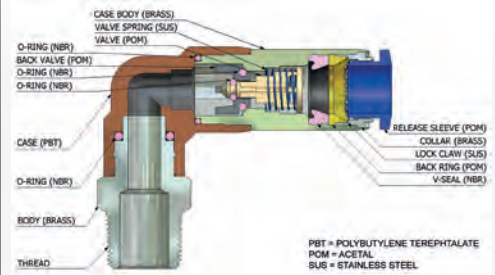

### SPECIFICATIONS

Suitability	Air (no other type of gas or liquid) <b>Do not use in water applications</b>
Working pressure	0 to 150 psi (10.3 bar)
Negative pressure	-29.5 in Hg / -750 mm Hg (-750 Torr)
Working temperature	0°C to 60°C (32°F to 140°F)
Application tube	Polyurethane & nylon

### METRIC TUBE TO THREAD

#### STRAIGHT BSPT MALE



PART NUMBER	TUBE OD	THREAD	BAG QTY
CDSPC0401	4 mm	1/8" BSPT	10
CDSPC0601	6 mm	1/8" BSPT	10
CDSPC0602	6 mm	1/4" BSPT	10
CDSPC0802	8 mm	1/4" BSPT	10
CDSPC0803	8 mm	3/8" BSPT	10
CDSPC1002	10 mm	1/4" BSPT	10
CDSPC1003	10 mm	3/8" BSPT	10
CDSPC1004	10 mm	1/2" BSPT	10
CDSPC1202	12 mm	1/4" BSPT	5
CDSPC1203	12 mm	3/8" BSPT	5
CDSPC1204	12 mm	1/2" BSPT	5

#### STRAIGHT BSPP MALE



PART NUMBER	TUBE OD	THREAD	BAG QTY
CDSPC04G01	4 mm	1/8" BSPP	10
CDSPC06G01	6 mm	1/8" BSPP	10
CDSPC06G02	6 mm	1/4" BSPP	10
CDSPC08G02	8 mm	1/4" BSPP	10
CDSPC08G03	8 mm	3/8" BSPP	10
CDSPC10G02	10 mm	1/4" BSPP	10
CDSPC10G03	10 mm	3/8" BSPP	10
CDSPC10G04	10 mm	1/2" BSPP	10
CDSPC12G02	12 mm	1/4" BSPP	5
CDSPC12G03	12 mm	3/8" BSPP	5
CDSPC12G04	12 mm	1/2" BSPP	5

#### ELBOW BSPT MALE



PART NUMBER	TUBE OD	THREAD	BAG QTY
CDSP40401	4 mm	1/8" BSPT	10
CDSP40601	6 mm	1/8" BSPT	10
CDSP40602	6 mm	1/4" BSPT	10
CDSP40801	8 mm	1/8" BSPT	10
CDSP40802	8 mm	1/4" BSPT	10
CDSP40803	8 mm	3/8" BSPT	10
CDSP41002	10 mm	1/4" BSPT	5
CDSP41003	10 mm	3/8" BSPT	5
CDSP41004	10 mm	1/2" BSPT	5
CDSP41203	12 mm	3/8" BSPT	5
CDSP41204	12 mm	1/2" BSPT	5

#### ELBOW METRIC MALE



PART NUMBER	TUBE OD	THREAD	BAG QTY
CDSP404M5	4 mm	M5 x 0.8	10
CDSP404M6	4 mm	M6 x 1.0	10
CDSP406M5	6 mm	M5 x 0.8	10

#### BSPP MALE

PART NUMBER	TUBE OD	THREAD	BAG QTY
CDSP404G01	4 mm	1/8" BSPP	10
CDSP406G01	6 mm	1/8" BSPP	10
CDSP406G02	6 mm	1/4" BSPP	10
CDSP408G01	8 mm	1/8" BSPP	10
CDSP408G02	8 mm	1/4" BSPP	10
CDSP408G03	8 mm	3/8" BSPP	10
CDSP410G02	10 mm	1/4" BSPP	5
CDSP410G03	10 mm	3/8" BSPP	5
CDSP410G04	10 mm	1/2" BSPP	5
CDSP412G03	12 mm	3/8" BSPP	5
CDSP412G04	12 mm	1/2" BSPP	5

### METRIC TUBE TO TUBE

#### STRAIGHT STOP UNION

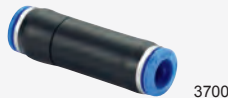

PART NUMBER	TUBE OD	BAG QTY
CDSPU04	4 mm	10
CDSPU06	6 mm	10
CDSPU08	8 mm	10
CDSPU10	10 mm	10
CDSPU12	12 mm	5

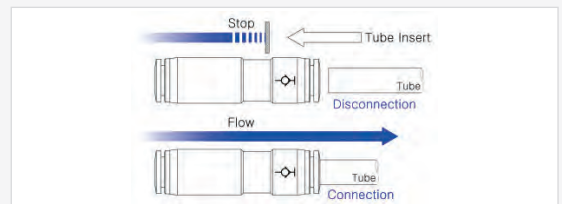

# CDC 10 Bar Speed Controllers

## Features

- Accurate regulation of an optimal airflow rate for precise motion control
- Tube direction and angle are controlled according to piping, as the main body can rotate up to 360° after assembly
- Needle rotation is increased to 10 – 12 times for easy speed and regular speed control
- Easy speed control with drive tools in limited and crowded spaces NSC (D) and NSC (DC) types
- Miniaturised products occupy small space attaching to devices

## Applications

- A valve to control the speed of the air pressure cylinders
- Mainly installed in the air cylinder

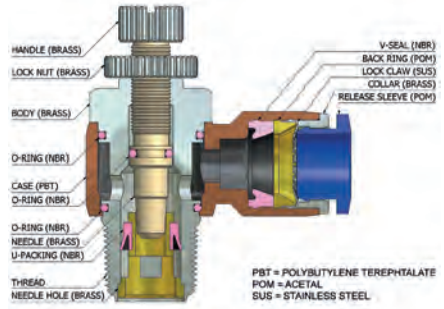

## SPECIFICATIONS

Suitability	Air (no other type of gas or liquid) <b>Do not use in water applications</b>
Working pressure	14.2 to 150 psi (1 to 10.3 bar)
Working temperature	0°C to 60°C (32°F to 140°F)

## METRIC TUBE TO THREAD



3700

SWIVEL ROTATING ELBOW  
BSPT MALE

PART NUMBER	TUBE OD	THREAD	BAG QTY
CDNSC0401N	4 mm	1/8" BSPT	10
CDNSC0402N	4 mm	1/4" BSPT	10
CDNSC0601N	6 mm	1/8" BSPT	10
CDNSC0602N	6 mm	1/4" BSPT	10
CDNSC0603N	6 mm	3/8" BSPT	5
CDNSC0604N	6 mm	1/2" BSPT	5
CDNSC0801N	8 mm	1/8" BSPT	10
CDNSC0802N	8 mm	1/4" BSPT	10
CDNSC0803N	8 mm	3/8" BSPT	5
CDNSC0804N	8 mm	1/2" BSPT	5
CDNSC1001N	10 mm	1/8" BSPT	5
CDNSC1002N	10 mm	1/4" BSPT	5
CDNSC1003N	10 mm	3/8" BSPT	5
CDNSC1004N	10 mm	1/2" BSPT	5
CDNSC1202N	12 mm	1/4" BSPT	5
CDNSC1203N	12 mm	3/8" BSPT	5
CDNSC1204N	12 mm	1/2" BSPT	5



3700

SWIVEL ROTATING ELBOW  
METRIC MALE

PART NUMBER	TUBE OD	THREAD	BAG QTY
CDNSC03M5N	3 mm	M5 x 0.8	10
CDNSC04M5N	4 mm	M5 x 0.8	10
CDNSC06M5N	6 mm	M5 x 0.8	10

## BSPP MALE

CDNSC04G1	4 mm	1/8" BSPP	10
CDNSC04G2	4 mm	1/4" BSPP	10
CDNSC06G1	6 mm	1/8" BSPP	10
CDNSC06G2	6 mm	1/4" BSPP	10
CDNSC06G3	6 mm	3/8" BSPP	5
CDNSC06G4	6 mm	1/2" BSPP	5
CDNSC08G1	8 mm	1/8" BSPP	10
CDNSC08G2	8 mm	1/4" BSPP	10
CDNSC08G3	8 mm	3/8" BSPP	5
CDNSC08G4	8 mm	1/2" BSPP	5
CDNSC10G1	10 mm	1/8" BSPP	5
CDNSC10G2	10 mm	1/4" BSPP	5
CDNSC10G3	10 mm	3/8" BSPP	5
CDNSC10G4	10 mm	1/2" BSPP	5
CDNSC12G2	12 mm	1/4" BSPP	5
CDNSC12G3	12 mm	3/8" BSPP	5
CDNSC12G4	12 mm	1/2" BSPP	5

## METER-OUT METHOD CONTROL (PREFERRED FOR CYLINDERS)

This product controls the air on the outlet to the tubing & allows free flow through the threaded port.

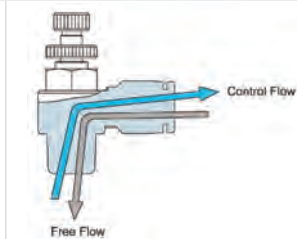

## IMPERIAL THREAD TO THREAD

SWIVEL ROTATING ELBOW  
METAL BODY  
BSPT MALE / BSPT FEMALE



3700

PART NUMBER	MALE THREAD	FEMALE THREAD	BAG QTY
CDNSCF01	1/8" BSPT	1/8" BSPT	10
CDNSCF02	1/4" BSPT	1/4" BSPT	5
CDNSCF03	3/8" BSPT	3/8" BSPT	5
CDNSCF04	1/2" BSPT	1/2" BSPT	3

METRIC TUBE TO THREAD



3700

SWIVEL KNURLED IN-LINE  
BSPT MALE

PART NUMBER	TUBE OD	THREAD	BAG QTY
CDNSS0401	4 mm	1/8" BSPT	10
CDNSS0402	4 mm	1/4" BSPT	10
CDNSS0601	6 mm	1/8" BSPT	5
CDNSS0602	6 mm	1/4" BSPT	5
CDNSS0603	6 mm	3/8" BSPT	5
CDNSS0801	8 mm	1/8" BSPT	5
CDNSS0802	8 mm	1/4" BSPT	5
CDNSS0803	8 mm	3/8" BSPT	5
CDNSS0804	8 mm	1/2" BSPT	4
CDNSS1002	10 mm	1/4" BSPT	5
CDNSS1003	10 mm	3/8" BSPT	5
CDNSS1004	10 mm	1/2" BSPT	4
CDNSS1202	12 mm	1/4" BSPT	3
CDNSS1203	12 mm	3/8" BSPT	3
CDNSS1204	12 mm	1/2" BSPT	3



3700

SWIVEL KNURLED IN-LINE  
METRIC MALE

PART NUMBER	TUBE OD	THREAD	BAG QTY
CDNSS04M5	4 mm	M5 x 0.8	10
CDNSS06M5	6 mm	M5 x 0.8	10

BSPP MALE

PART NUMBER	TUBE OD	THREAD	BAG QTY
CDNSS04G1	4 mm	1/8" BSPP	10
CDNSS04G2	4 mm	1/4" BSPP	10
CDNSS06G1	6 mm	1/8" BSPP	5
CDNSS06G2	6 mm	1/4" BSPP	5
CDNSS06G3	6 mm	3/8" BSPP	5
CDNSS08G1	8 mm	1/8" BSPP	5
CDNSS08G2	8 mm	1/4" BSPP	5
CDNSS08G3	8 mm	3/8" BSPP	5
CDNSS08G4	8 mm	1/2" BSPP	4
CDNSS10G2	10 mm	1/4" BSPP	5
CDNSS10G3	10 mm	3/8" BSPP	5
CDNSS10G4	10 mm	1/2" BSPP	4
CDNSS12G2	12 mm	1/4" BSPP	3
CDNSS12G3	12 mm	3/8" BSPP	3
CDNSS12G4	12 mm	1/2" BSPP	3

Eight



3700

SWIVEL ELBOW  
SCREWDRIVER SLOT  
BSPT MALE

PART NUMBER	TUBE OD	THREAD	BAG QTY
CDNSC0401D	4 mm	1/8" BSPT	10
CDNSC0402D	4 mm	1/4" BSPT	10
CDNSC0601D	6 mm	1/8" BSPT	10
CDNSC0602D	6 mm	1/4" BSPT	10
CDNSC0603D	6 mm	3/8" BSPT	5
CDNSC0604D	6 mm	1/2" BSPT	5
CDNSC0801D	8 mm	1/8" BSPT	10
CDNSC0802D	8 mm	1/4" BSPT	10
CDNSC0803D	8 mm	3/8" BSPT	5
CDNSC0804D	8 mm	1/2" BSPT	5
CDNSC1001D	10 mm	1/8" BSPT	5
CDNSC1002D	10 mm	1/4" BSPT	5
CDNSC1003D	10 mm	3/8" BSPT	5
CDNSC1004D	10 mm	1/2" BSPT	5
CDNSC1202D	12 mm	1/4" BSPT	5
CDNSC1203D	12 mm	3/8" BSPT	5
CDNSC1204D	12 mm	1/2" BSPT	5



3700

SWIVEL ELBOW  
SCREWDRIVER SLOT  
METRIC MALE

PART NUMBER	TUBE OD	THREAD	BAG QTY
CDNSC03M5D	3 mm	M5 x 0.8	10
CDNSC04M5D	4 mm	M5 x 0.8	10
CDNSC06M5D	6 mm	M5 x 0.8	10

BSPP MALE

PART NUMBER	TUBE OD	THREAD	BAG QTY
CDNSC04G1D	4 mm	1/8" BSPP	10
CDNSC04G2D	4 mm	1/4" BSPP	10
CDNSC06G1D	6 mm	1/8" BSPP	10
CDNSC06G2D	6 mm	1/4" BSPP	10
CDNSC06G3D	6 mm	3/8" BSPP	5
CDNSC06G4D	6 mm	1/2" BSPP	5
CDNSC08G1D	8 mm	1/8" BSPP	10
CDNSC08G2D	8 mm	1/4" BSPP	10
CDNSC08G3D	8 mm	3/8" BSPP	5
CDNSC08G4D	8 mm	1/2" BSPP	5
CDNSC10G1D	10 mm	1/8" BSPP	5
CDNSC10G2D	10 mm	1/4" BSPP	5
CDNSC10G3D	10 mm	3/8" BSPP	5
CDNSC10G4D	10 mm	1/2" BSPP	5
CDNSC12G2D	12 mm	1/4" BSPP	5
CDNSC12G3D	12 mm	3/8" BSPP	5
CDNSC12G4D	12 mm	1/2" BSPP	5

METRIC TUBE TO THREAD



SWIVEL IN-LINE  
SCREWDRIVER SLOT  
BSPT MALE

PART NUMBER	TUBE OD	THREAD	BAG QTY
CDNSS0401D	4 mm	1/8" BSPT	10
CDNSS0402D	4 mm	1/4" BSPT	10
CDNSS0601D	6 mm	1/8" BSPT	5
CDNSS0602D	6 mm	1/4" BSPT	5
CDNSS0603D	6 mm	3/8" BSPT	5
CDNSS0801D	8 mm	1/8" BSPT	5
CDNSS0802D	8 mm	1/4" BSPT	5
CDNSS0803D	8 mm	3/8" BSPT	5
CDNSS0804D	8 mm	1/2" BSPT	4
CDNSS1002D	10 mm	1/4" BSPT	5
CDNSS1003D	10 mm	3/8" BSPT	5
CDNSS1004D	10 mm	1/2" BSPT	4
CDNSS1202D	12 mm	1/4" BSPT	3
CDNSS1203D	12 mm	3/8" BSPT	3
CDNSS1204D	12 mm	1/2" BSPT	3

SWIVEL IN-LINE  
SCREWDRIVER SLOT  
METRIC MALE

PART NUMBER	TUBE OD	THREAD	BAG QTY
CDNSS04M5D	4 mm	M5 x 0.8	10
CDNSS06M5D	6 mm	M5 x 0.8	10

BSPP MALE

PART NUMBER	TUBE OD	THREAD	BAG QTY
CDNSS04G1D	4 mm	1/8" BSPP	10
CDNSS04G2D	4 mm	1/4" BSPP	10
CDNSS06G1D	6 mm	1/8" BSPP	5
CDNSS06G2D	6 mm	1/4" BSPP	5
CDNSS06G3D	6 mm	3/8" BSPP	5
CDNSS08G1D	8 mm	1/8" BSPP	5
CDNSS08G2D	8 mm	1/4" BSPP	5
CDNSS08G3D	8 mm	3/8" BSPP	5
CDNSS08G4D	8 mm	1/2" BSPP	4
CDNSS10G2D	10 mm	1/4" BSPP	5
CDNSS10G3D	10 mm	3/8" BSPP	5
CDNSS10G4D	10 mm	1/2" BSPP	4
CDNSS12G2D	12 mm	1/4" BSPP	3
CDNSS12G3D	12 mm	3/8" BSPP	3
CDNSS12G4D	12 mm	1/2" BSPP	3



SWIVEL ELBOW  
CAPTIVE SCREWDRIVER SLOT  
BSPT MALE

PART NUMBER	TUBE OD	THREAD	BAG QTY
CDNSC0401DC	4 mm	1/8" BSPT	10
CDNSC0402DC	4 mm	1/4" BSPT	10
CDNSC0601DC	6 mm	1/8" BSPT	10
CDNSC0602DC	6 mm	1/4" BSPT	10
CDNSC0603DC	6 mm	3/8" BSPT	5
CDNSC0604DC	6 mm	1/2" BSPT	5
CDNSC0801DC	8 mm	1/8" BSPT	10
CDNSC0802DC	8 mm	1/4" BSPT	10
CDNSC0803DC	8 mm	3/8" BSPT	5
CDNSC0804DC	8 mm	1/2" BSPT	5
CDNSC1001DC	10 mm	1/8" BSPT	5
CDNSC1002DC	10 mm	1/4" BSPT	5
CDNSC1003DC	10 mm	3/8" BSPT	5
CDNSC1004DC	10 mm	1/2" BSPT	5
CDNSC1202DC	12 mm	1/4" BSPT	5
CDNSC1203DC	12 mm	3/8" BSPT	5
CDNSC1204DC	12 mm	1/2" BSPT	5

SWIVEL ELBOW  
CAPTIVE SCREWDRIVER SLOT  
METRIC MALE  
SOLD IN PACKS OF 10

PART NUMBER	TUBE OD	THREAD	BAG QTY
CDNSC03M5DC	3 mm	M5 x 0.8	10
CDNSC04M5DC	4 mm	M5 x 0.8	10
CDNSC06M5DC	6 mm	M5 x 0.8	10

BSPP MALE

PART NUMBER	TUBE OD	THREAD	BAG QTY
CDNSC04G1DC	4 mm	1/8" BSPP	10
CDNSC04G2DC	4 mm	1/4" BSPP	10
CDNSC06G1DC	6 mm	1/8" BSPP	10
CDNSC06G2DC	6 mm	1/4" BSPP	10
CDNSC06G3DC	6 mm	3/8" BSPP	5
CDNSC06G4DC	6 mm	1/2" BSPP	5
CDNSC08G1DC	8 mm	1/8" BSPP	10
CDNSC08G2DC	8 mm	1/4" BSPP	10
CDNSC08G3DC	8 mm	3/8" BSPP	5
CDNSC08G4DC	8 mm	1/2" BSPP	5
CDNSC10G1DC	10 mm	1/8" BSPP	5
CDNSC10G2DC	10 mm	1/4" BSPP	5
CDNSC10G3DC	10 mm	3/8" BSPP	5
CDNSC10G4DC	10 mm	1/2" BSPP	5
CDNSC12G2DC	12 mm	1/4" BSPP	5
CDNSC12G3DC	12 mm	3/8" BSPP	5
CDNSC12G4DC	12 mm	1/2" BSPP	5

METRIC TUBE TO THREAD



3700

SWIVEL ROTATING IN-LINE  
CAPTIVE SCREWDRIVER SLOT  
BSPT MALE

PART NUMBER	TUBE OD	THREAD	BAG QTY
CDNSS0401DC	4 mm	1/8" BSPT	10
CDNSS0402DC	4 mm	1/4" BSPT	10
CDNSS0601DC	6 mm	1/8" BSPT	5
CDNSS0602DC	6 mm	1/4" BSPT	5
CDNSS0603DC	6 mm	3/8" BSPT	5
CDNSS0801DC	8 mm	1/8" BSPT	5
CDNSS0802DC	8 mm	1/4" BSPT	5
CDNSS0803DC	8 mm	3/8" BSPT	5
CDNSS0804DC	8 mm	1/2" BSPT	4
CDNSS1002DC	10 mm	1/4" BSPT	5
CDNSS1003DC	10 mm	3/8" BSPT	5
CDNSS1004DC	10 mm	1/2" BSPT	4
CDNSS1202DC	12 mm	1/4" BSPT	3
CDNSS1203DC	12 mm	3/8" BSPT	3
CDNSS1204DC	12 mm	1/2" BSPT	3



3700

SWIVEL ROTATING IN-LINE  
CAPTIVE SCREWDRIVER SLOT  
METRIC MALE

PART NUMBER	TUBE OD	THREAD	BAG QTY
CDNSS04M5DC	4 mm	M5 x 0.8	10
CDNSS06M5DC	6 mm	M5 x 0.8	10

BSPP MALE

PART NUMBER	TUBE OD	THREAD	BAG QTY
CDNSS04G1DC	4 mm	1/8" BSPP	10
CDNSS04G2DC	4 mm	1/4" BSPP	10
CDNSS06G1DC	6 mm	1/8" BSPP	5
CDNSS06G2DC	6 mm	1/4" BSPP	5
CDNSS06G3DC	6 mm	3/8" BSPP	5
CDNSS08G1DC	8 mm	1/8" BSPP	5
CDNSS08G2DC	8 mm	1/4" BSPP	5
CDNSS08G3DC	8 mm	3/8" BSPP	5
CDNSS08G4DC	8 mm	1/2" BSPP	4
CDNSS10G2DC	10 mm	1/4" BSPP	5
CDNSS10G3DC	10 mm	3/8" BSPP	5
CDNSS10G4DC	10 mm	1/2" BSPP	4
CDNSS12G2DC	12 mm	1/4" BSPP	3
CDNSS12G3DC	12 mm	3/8" BSPP	3
CDNSS12G4DC	12 mm	1/2" BSPP	3

Eight

METRIC TUBE TO TUBE



3700

STRAIGHT UNION

PART NUMBER	TUBE OD	BAG QTY
CDNSF04N	4 mm	10
CDNSF06N	6 mm	10
CDNSF08N	8 mm	5
CDNSF10N	10 mm	5
CDNSF12N	12 mm	3

IMPERIAL TUBE TO TUBE



3700

STRAIGHT UNION

PART NUMBER	TUBE OD	BAG QTY
CDNSF1/4	1/4"	10
CDNSF3/8	3/8"	5
CDNSF1/2	1/2"	3



3700

STRAIGHT  
BULKHEAD UNION

PART NUMBER	TUBE OD	BAG QTY
CDNSFB04N	4 mm	10
CDNSFB06N	6 mm	5
CDNSFB08N	8 mm	5
CDNSFB10N	10 mm	3
CDNSFB12N	12 mm	3

SPEED CONTROLLERS WITH PILOT CHECK VALVES – TUBE TO THREAD

# CDC 10 Bar Speed Controllers with Pilot Check Valves

**FEATURES**

- Realises momentary intermediate stoppage of a cylinder & able to adjust speed control of it
- Combined pilot check valve & speed controller
- Enables 360° free direction of tubing mount

**SPECIFICATIONS**

Suitability	Air (no other type of gas or liquid) <b>Do not use in water applications</b>
Working pressure	14.2 to 150 psi (1 to 10.3 bar)
Working temperature	0°C to 60°C (32°F to 140°F)
Application tube	Polyurethane & nylon

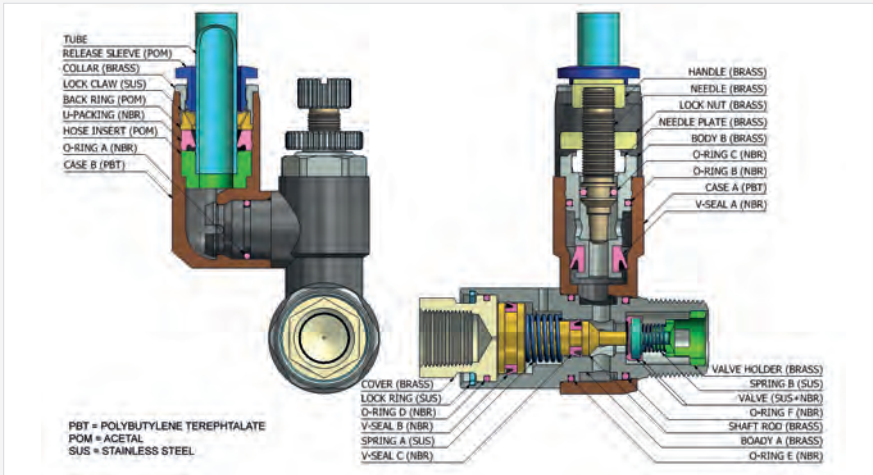

SWIVEL ROTATING WITH PILOT CHECK VALVE BSPT MALE 3700

PART NUMBER	TUBE OD A	THREAD B	PILOT PORT (C)	BAG QTY
CDPVSC0601	6 mm	1/8" BSPT	M5	5
CDPVSC0602	6 mm	1/4" BSPT	1/8" BSPT	5
CDPVSC0801	8 mm	1/8" BSPT	M5	5
CDPVSC0802	8 mm	1/4" BSPT	1/8" BSPT	5
CDPVSC0803	8 mm	3/8" BSPT	1/8" BSPT	3
CDPVSC1003	10 mm	3/8" BSPT	1/8" BSPT	3
CDPVSC1004	10 mm	1/2" BSPT	1/4" BSPT	2
CDPVSC1203	12 mm	3/8" BSPT	1/8" BSPT	2
CDPVSC1204	12 mm	1/2" BSPT	1/4" BSPT	2



SWIVEL ROTATING WITH PILOT CHECK VALVE BSPP MALE 3700

PART NUMBER	TUBE OD A	THREAD B	PILOT PORT (C)	BAG QTY
CDPVSC06G1	6 mm	1/8" BSPP	M5	5
CDPVSC06G2	6 mm	1/4" BSPP	1/8" BSPT	5
CDPVSC08G1	8 mm	1/8" BSPP	M5	5
CDPVSC08G2	8 mm	1/4" BSPP	1/8" BSPT	5
CDPVSC08G3	8 mm	3/8" BSPP	1/8" BSPT	3
CDPVSC10G3	10 mm	3/8" BSPP	1/8" BSPT	3
CDPVSC10G4	10 mm	1/2" BSPP	1/4" BSPT	2
CDPVSC12G3	12 mm	3/8" BSPP	1/8" BSPT	2
CDPVSC12G4	12 mm	1/2" BSPP	1/4" BSPT	2

PILOT CHECK VALVES



SWIVEL ELBOW – METAL BODY BSPT MALE / BSPT FEMALE 3700

PART NUMBER	THREAD A	PILOT B	BAG QTY
CDPVSF01N	1/8" BSPT	M5	10
CDPVSF02N	1/4" BSPT	1/8"	5
CDPVSF03N	3/8" BSPT	1/8"	3
CDPVSF04N	1/2" BSPT	1/4"	3



SWIVEL ELBOW – METAL BODY BSPP MALE / BSPP FEMALE 3700

PART NUMBER	THREAD A	PILOT B	BAG QTY
CDPVSG01N	1/8" BSPP	M5	10
CDPVSG02N	1/4" BSPP	1/8"	5
CDPVSG03N	3/8" BSPP	1/8"	3
CDPVSG04N	1/2" BSPP	1/4"	3



# PARKAIR® Brass Nickel Plated Push-In Fittings

**Description**

Full metal solution offers a heavy duty, robust, higher performance. Suitable for use with strong vibrations, abrasions and welding sparks. Double O-ring design for better swivel. Widely used in robotics, automotive welding, heavy industry, railway, compressed air circuit, and vacuum.

**Materials**

Body: Brass  
 Collar and sleeve: Brass  
 Colour: Nickel plated  
 Seals: NBR  
 Gripping teeth: Stainless steel

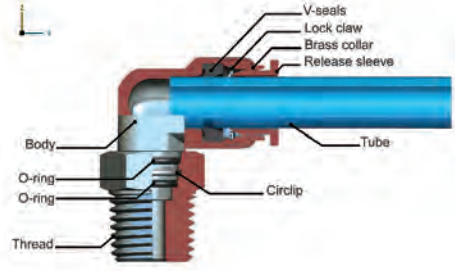
**SPECIFICATIONS**

Medium	Air
Working pressure	0 to 15 bar (0 to 217 psi)
Negative pressure	-29.5 Hg
Working temperature	-20°C to +80°C
Tube sizes	Metric
Thread sizes	BSPT, BSPP
Applicable tubings	PU, PE, PA, PTFE, FEP

**STUD COUPLING  
METRIC MALE**

PART NUMBER	TUBE OD	THREAD
BMPC4-M5	4 mm	M5
BMPC4-M6	4 mm	M6
BMPC6-M5	6 mm	M5
BMPC6-M6	6 mm	M6

**SWIVEL STUD ELBOW  
METRIC MALE**

PART NUMBER	TUBE OD	THREAD
BMPL4-M5	4 mm	M5
BMPL4-M6	4 mm	M6
BMPL6-M5	6 mm	M5
BMPL6-M6	6 mm	M6

**BSPT MALE**

BMPC4-01	4 mm	1/8" BSPT
BMPC4-02	4 mm	1/4" BSPT
BMPC6-01	6 mm	1/8" BSPT
BMPC6-02	6 mm	1/4" BSPT
BMPC6-03	6 mm	3/8" BSPT
BMPC8-01	8 mm	1/8" BSPT
BMPC8-02	8 mm	1/4" BSPT
BMPC8-03	8 mm	3/8" BSPT
BMPC10-02	10 mm	1/4" BSPT
BMPC10-03	10 mm	3/8" BSPT
BMPC10-04	10 mm	1/2" BSPT
BMPC12-02	12 mm	1/4" BSPT
BMPC12-03	12 mm	3/8" BSPT
BMPC12-04	12 mm	1/2" BSPT

**BSPT MALE**

BMPL4-01	4 mm	1/8" BSPT
BMPL4-02	4 mm	1/4" BSPT
BMPL6-01	6 mm	1/8" BSPT
BMPL6-02	6 mm	1/4" BSPT
BMPL6-03	6 mm	3/8" BSPT
BMPL8-01	8 mm	1/8" BSPT
BMPL8-02	8 mm	1/4" BSPT
BMPL8-03	8 mm	3/8" BSPT
BMPL8-04	8 mm	1/2" BSPT
BMPL10-02	10 mm	1/4" BSPT
BMPL10-03	10 mm	3/8" BSPT
BMPL10-04	10 mm	1/2" BSPT
BMPL12-02	12 mm	1/4" BSPT
BMPL12-03	12 mm	3/8" BSPT
BMPL12-04	12 mm	1/2" BSPT

**STUD TEE  
BSPT MALE**

PART NUMBER	TUBE OD	THREAD
BMPT4-01	4 mm	1/8" BSPT
BMPT4-02	4 mm	1/4" BSPT
BMPT6-01	6 mm	1/8" BSPT
BMPT6-02	6 mm	1/4" BSPT
BMPT6-03	6 mm	3/8" BSPT
BMPT8-02	8 mm	1/4" BSPT
BMPT8-03	8 mm	3/8" BSPT
BMPT10-02	10 mm	1/4" BSPT
BMPT10-03	10 mm	3/8" BSPT
BMPT12-03	12 mm	3/8" BSPT
BMPT12-04	12 mm	1/2" BSPT

**STUD COUPLING  
BSPP FEMALE**

PART NUMBER	TUBE OD	THREAD
BMPCF4-G01	4 mm	1/8" BSPP
BMPCF6-G01	6 mm	1/8" BSPP
BMPCF6-G02	6 mm	1/4" BSPP
BMPCF8-G02	8 mm	1/4" BSPP
BMPCF10-G02	10 mm	1/4" BSPP
BMPCF12-G03	12 mm	3/8" BSPP
BMPCF12-G04	12 mm	1/2" BSPP



EQUAL STRAIGHT CONNECTOR

3540

PART NUMBER	TUBE OD
BMPUC4	4 mm
BMPUC6	6 mm
BMPUC8	8 mm
BMPUC10	10 mm
BMPUC12	12 mm



EQUAL ELBOW

3540

PART NUMBER	TUBE OD
BMPUL4	4 mm
BMPUL6	6 mm
BMPUL8	8 mm
BMPUL10	10 mm
BMPUL12	12 mm



PLUG-IN REDUCER

3540

PART NUMBER	TUBE OD	STEM OD
BMPGJ6-4	4 mm	6 mm
BMPGJ8-6	6 mm	8 mm
BMPGJ10-8	8 mm	10 mm
BMPGJ12-8	8 mm	12 mm
BMPGJ12-10	10 mm	12 mm



EQUAL TEE

3540

PART NUMBER	TUBE OD
BMPUT4	4 mm
BMPUT6	6 mm
BMPUT8	8 mm
BMPUT10	10 mm
BMPUT12	12 mm



EQUAL BULKHEAD CONNECTOR

3540

PART NUMBER	TUBE OD
BMPM4	4 mm
BMPM6	6 mm
BMPM8	8 mm
BMPM10	10 mm
BMPM12	12 mm



EQUAL Y

3540

PART NUMBER	TUBE OD
BMPY4	4 mm
BMPY6	6 mm
BMPY8	8 mm
BMPY10	10 mm
BMPY12	12 mm

Do you also need?

**PARKAIR®**

**Stainless steel push-in fittings**



Find it on page 545, section eight

Do you also need?

**CD PNEUMATICS**

**Polyurethane tubing**



Find it on pages 644 – 645, section ten

# Aignep Push-In Fittings

Aignep push-in fittings feature a clamping washer made of stainless steel, ensuring perfect clamping without marking tubes, even in severe conditions. The geometric seal design provides a vacuum-tight seal.

### Threads

Tapered gas in conformity with ISO 7.1, BS 21, DIN 2999.  
Parallel gas in conformity with ISO 288 Class A.  
Metric in conformity with ISO R/262

### Suitability

Compressed air, vacuum.

### Connection tubes

Plastic tubes: PA6, PA11, PA12, polyethylene, \*polyurethane, etc.  
\*For polyurethane hoses, a minimum hardness of 98 shore is required.

### Specifications

Pressure range: -0.99 bar to 15 bar  
Temperature range: -20°C to +80°C

### Materials

Body: Nickel plated brass  
Collet: Acetalic resin  
Capsule: Nickel plated brass  
Clamping washer: Stainless steel  
Safety ring: Technopolymer  
Lip seal: NBR 70  
Thread sealing ring: NBR 90



Eight

**STRAIGHT ADAPTOR  
WITH NBR90 SEAL RING  
BSPT MALE**



1410

PART NUMBER	TUBE OD	THREAD
A5000-0418	4 mm	1/8" BSPT
A5000-0414	4 mm	1/4" BSPT
A5000-0518	5 mm	1/8" BSPT
A5000-0514	5 mm	1/4" BSPT
A5000-0618	6 mm	1/8" BSPT
A5000-0614	6 mm	1/4" BSPT
A5000-0638	6 mm	3/8" BSPT
A5000-0612	6 mm	1/2" BSPT
A5000-0818	8 mm	1/8" BSPT
A5000-0814	8 mm	1/4" BSPT
A5000-0838	8 mm	3/8" BSPT
A5000-0812	8 mm	1/2" BSPT
A5000-1014	10 mm	1/4" BSPT
A5000-1038	10 mm	3/8" BSPT
A5000-1012	10 mm	1/2" BSPT
A5000-1214	12 mm	1/4" BSPT
A5000-1238	12 mm	3/8" BSPT
A5000-1212	12 mm	1/2" BSPT
A5000-1438	14 mm	3/8" BSPT
A5000-1412	14 mm	1/2" BSPT

**STRAIGHT ADAPTOR – INTERNAL  
HEXAGON WITH NBR90 SEAL RING  
METRIC MALE**



1410

PART NUMBER	TUBE OD	THREAD
A5010-03M5	3 mm	M5
A5010-04M5	4 mm	M5
A5010-04M7	4 mm	M7 x 1
A5010-06M5	6 mm	M5

### BSPT MALE

PART NUMBER	TUBE OD	THREAD
A5010-0418	4 mm	1/8" BSPT
A5010-0618	6 mm	1/8" BSPT
A5010-0614	6 mm	1/4" BSPT
A5010-0818	8 mm	1/8" BSPT
A5010-0814	8 mm	1/4" BSPT

**STRAIGHT ADAPTOR  
WITH O-RING SEAL  
METRIC MALE**



1410

PART NUMBER	TUBE OD	THREAD
A5020-03M5	3 mm	M5
A5020-04M5	4 mm	M5
A5020-05M5	5 mm	M5
A5020-06M5	6 mm	M5

**BSPP MALE**

A5020-0418	4 mm	1/8" BSPP
A5020-0414	4 mm	1/4" BSPP
A5020-0518	5 mm	1/8" BSPP
A5020-0618	6 mm	1/8" BSPP
A5020-0614	6 mm	1/4" BSPP
A5020-0638	6 mm	3/8" BSPP
A5020-0612	6 mm	1/2" BSPP
A5020-0818	8 mm	1/8" BSPP
A5020-0814	8 mm	1/4" BSPP
A5020-0838	8 mm	3/8" BSPP
A5020-0812	8 mm	1/2" BSPP
A5020-1014	10 mm	1/4" BSPP
A5020-1038	10 mm	3/8" BSPP
A5020-1012	10 mm	1/2" BSPP
A5020-1214	12 mm	1/4" BSPP
A5020-1238	12 mm	3/8" BSPP
A5020-1212	12 mm	1/2" BSPP
A5020-1438	14 mm	3/8" BSPP
A5020-1412	14 mm	1/2" BSPP

**STRAIGHT ADAPTOR  
METRIC FEMALE**



1410

PART NUMBER	TUBE OD	THREAD
A5030-03M5	3 mm	M5
A5030-04M5	4 mm	M5

**BSPP FEMALE**

A5030-0418	4 mm	1/8" BSPP
A5030-0414	4 mm	1/4" BSPP
A5030-0518	5 mm	1/8" BSPP
A5030-0618	6 mm	1/8" BSPP
A5030-0614	6 mm	1/4" BSPP
A5030-0818	8 mm	1/8" BSPP
A5030-0814	8 mm	1/4" BSPP
A5030-0838	8 mm	3/8" BSPP
A5030-1014	10 mm	1/4" BSPP
A5030-1038	10 mm	3/8" BSPP
A5030-1012	10 mm	1/2" BSPP
A5030-1238	12 mm	3/8" BSPP
A5030-1212	12 mm	1/2" BSPP

**BULKHEAD CONNECTOR  
EQUAL**



1410

PART NUMBER	TUBE OD	BODY THREAD
A5050-03M10	3 mm	M10 x 1
A5050-04M12	4 mm	M12 x 1
A5050-05M14	5 mm	M14 x 1
A5050-06M14	6 mm	M14 x 1
A5050-08M16	8 mm	M16 x 1
A5050-10M20	10 mm	M20 x 1
A5050-12M22	12 mm	M22 x 1

**STRAIGHT CONNECTOR**



1410

PART NUMBER	TUBE OD	TUBE OD
A5040-0303	3 mm	3 mm
A5040-0404	4 mm	4 mm
A5040-0505	5 mm	5 mm
A5040-0604	6 mm	4 mm
A5040-0606	6 mm	6 mm
A5040-0806	8 mm	6 mm
A5040-0808	8 mm	8 mm
A5040-1008	10 mm	8 mm
A5040-1010	10 mm	10 mm
A5040-1210	12 mm	10 mm
A5040-1212	12 mm	12 mm
A5040-1414	14 mm	14 mm

**REDUCER**



1410

PART NUMBER	TUBE OD A	TUBE OD B
A5070-0403	4 mm	3 mm
A5070-0504	5 mm	4 mm
A5070-0604	6 mm	4 mm
A5070-0605	6 mm	5 mm
A5070-0804	8 mm	4 mm
A5070-0806	8 mm	6 mm
A5070-1004	10 mm	4 mm
A5070-1008	10 mm	8 mm
A5070-1208	12 mm	8 mm

**STRAIGHT ADAPTOR  
METRIC MALE**



1410

PART NUMBER	TUBE OD	THREAD
A50600-04M5	4 mm	M5
A50600-05M5	5 mm	M5
A50600-06M5	6 mm	M5

**BSPP MALE**

A50600-0418	4 mm	1/8" BSPP
A50600-0518	5 mm	1/8" BSPP
A50600-0514	5 mm	1/4" BSPP
A50600-0618	6 mm	1/8" BSPP
A50600-0614	6 mm	1/4" BSPP
A50600-0818	8 mm	1/8" BSPP
A50600-0814	8 mm	1/4" BSPP
A50600-0838	8 mm	3/8" BSPP
A50600-1018	10 mm	1/8" BSPP
A50600-1014	10 mm	1/4" BSPP
A50600-1038	10 mm	3/8" BSPP
A50600-1214	12 mm	1/4" BSPP
A50600-1238	12 mm	3/8" BSPP



SWIVEL ELBOW  
BSPT FEMALE

1410

PART NUMBER	TUBE OD	THREAD
A5106-0418	4 mm	1/8" BSPT
A5106-0414	4 mm	1/4" BSPT
A5106-0618	6 mm	1/8" BSPT
A5106-0614	6 mm	1/4" BSPT
A5106-0818	8 mm	1/8" BSPT
A5106-0814	8 mm	1/4" BSPT

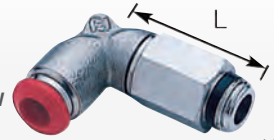

EXTENDED SWIVEL ELBOW  
WITH NBR90 SEAL RING  
BSPT MALE

1410

PART NUMBER	TUBE OD	THREAD	LENGTH (L)
A5121-0418	4 mm	1/8" BSPT	30.0 mm
A5121-0414	4 mm	1/4" BSPT	31.5 mm
A5121-0518	5 mm	1/8" BSPT	34.2 mm
A5121-0618	6 mm	1/8" BSPT	34.2 mm
A5121-0614	6 mm	1/4" BSPT	35.7 mm
A5121-0818	8 mm	1/8" BSPT	38.2 mm
A5121-0814	8 mm	1/4" BSPT	38.2 mm
A5121-0838	8 mm	3/8" BSPT	38.7 mm
A5121-1014	10 mm	1/4" BSPT	45.2 mm
A5121-1038	10 mm	3/8" BSPT	43.2 mm



ELBOW  
EQUAL

1410

PART NUMBER	TUBE OD
A5130-03	3 mm
A5130-04	4 mm
A5130-05	5 mm
A5130-06	6 mm
A5130-08	8 mm
A5130-10	10 mm
A5130-12	12 mm
A5130-14	14 mm

FIXED ELBOW  
WITH NBR90 SEAL RING  
METRIC MALE



1410

PART NUMBER	TUBE OD	THREAD
A5100-04M5	4 mm	M5
A5100-05M5	5 mm	M5

BSPT MALE

A5100-0418	4 mm	1/8" BSPT
A5100-0518	5 mm	1/8" BSPT
A5100-0618	6 mm	1/8" BSPT
A5100-0614	6 mm	1/4" BSPT
A5100-0818	8 mm	1/8" BSPT
A5100-0814	8 mm	1/4" BSPT
A5100-1014	10 mm	1/4" BSPT
A5100-1038	10 mm	3/8" BSPT
A5100-1214	12 mm	1/4" BSPT
A5100-1238	12 mm	3/8" BSPT



SWIVEL ELBOW  
WITH NBR90 SEAL RING  
BSPT MALE

1410

PART NUMBER	TUBE OD	THREAD
A5111-0418	4 mm	1/8" BSPT
A5111-0414	4 mm	1/4" BSPT
A5111-0518	5 mm	1/8" BSPT
A5111-0618	6 mm	1/8" BSPT
A5111-0614	6 mm	1/4" BSPT
A5111-0818	8 mm	1/8" BSPT
A5111-0814	8 mm	1/4" BSPT
A5111-0838	8 mm	3/8" BSPT
A5111-0812	8 mm	1/2" BSPT
A5111-1014	10 mm	1/4" BSPT
A5111-1038	10 mm	3/8" BSPT
A5111-1012	10 mm	1/2" BSPT
A5111-1238	12 mm	3/8" BSPT
A5111-1212	12 mm	1/2" BSPT
A5111-1438	14 mm	3/8" BSPT
A5111-1412	14 mm	1/2" BSPT

TEE  
EQUAL



1410

PART NUMBER	TUBE OD
A5230-03	3 mm
A5230-04	4 mm
A5230-05	5 mm
A5230-06	6 mm
A5230-08	8 mm
A5230-10	10 mm
A5230-12	12 mm
A5230-14	14 mm



SWIVEL CENTRE LEG TEE  
WITH NBR90 SEAL RING  
BSPT MALE

1410

PART NUMBER	TUBE OD	THREAD
A5211-0418	4 mm	1/8" BSPT
A5211-0414	4 mm	1/4" BSPT
A5211-0518	5 mm	1/8" BSPT
A5211-0618	6 mm	1/8" BSPT
A5211-0614	6 mm	1/4" BSPT
A5211-0818	8 mm	1/8" BSPT
A5211-0814	8 mm	1/4" BSPT
A5211-0838	8 mm	3/8" BSPT
A5211-0812	8 mm	1/2" BSPT
A5211-1014	10 mm	1/4" BSPT
A5211-1038	10 mm	3/8" BSPT
A5211-1012	10 mm	1/2" BSPT
A5211-1238	12 mm	3/8" BSPT
A5211-1212	12 mm	1/2" BSPT
A5211-1438	14 mm	3/8" BSPT
A5211-1412	14 mm	1/2" BSPT



Y CONNECTOR  
EQUAL

1410

PART NUMBER	TUBE OD
A5310-03	3 mm
A5310-04	4 mm
A5310-05	5 mm
A5310-06	6 mm
A5310-08	8 mm



FIXED CENTRE LEG TEE  
WITH NBR90 SEAL RING  
METRIC MALE

1410

PART NUMBER	TUBE OD	THREAD
A5200-04M5	4 mm	M5

BSPT MALE

PART NUMBER	TUBE OD	THREAD
A5200-0418	4 mm	1/8" BSPT
A5200-0518	5 mm	1/8" BSPT
A5200-0618	6 mm	1/8" BSPT
A5200-0818	8 mm	1/8" BSPT
A5200-0814	8 mm	1/4" BSPT
A5200-1014	10 mm	1/4" BSPT
A5200-1038	10 mm	3/8" BSPT
A5200-1214	12 mm	1/4" BSPT
A5200-1238	12 mm	3/8" BSPT



PLUG  
POLYAMIDE

1410

PART NUMBER	TUBE OD
A8610-03	3 mm
A8610-04	4 mm
A8610-05	5 mm
A8610-06	6 mm
A8610-08	8 mm
A8610-10	10 mm
A8610-12	12 mm



SPLICER

1410

PART NUMBER	TUBE OD
A50625-04	4 mm
A50625-05	5 mm
A50625-06	6 mm
A50625-08	8 mm
A50625-10	10 mm
A50625-12	12 mm



SWIVEL OFF SET LEG TEE  
WITH NBR90 SEAL RING  
BSPT MALE

1410

PART NUMBER	TUBE OD	THREAD
A5223-0418	4 mm	1/8" BSPT
A5223-0414	4 mm	1/4" BSPT
A5223-0518	5 mm	1/8" BSPT
A5223-0618	6 mm	1/8" BSPT
A5223-0614	6 mm	1/4" BSPT
A5223-0818	8 mm	1/8" BSPT
A5223-0814	8 mm	1/4" BSPT
A5223-0838	8 mm	3/8" BSPT
A5223-0812	8 mm	1/2" BSPT
A5223-1014	10 mm	1/4" BSPT
A5223-1038	10 mm	3/8" BSPT
A5223-1012	10 mm	1/2" BSPT
A5223-1238	12 mm	3/8" BSPT
A5223-1212	12 mm	1/2" BSPT



TOOL FOR DISASSEMBLING

1410

PART NUMBER	DESCRIPTION
A5990	Disassembling tool



ALUMINIUM MANIFOLD  
5-WAY

1410

PART NUMBER	TUBE OD	THREAD
A5900-0418	4 mm	1/8"
A5900-0618	6 mm	1/8"
A5900-0614	6 mm	1/4"
A5900-0814	8 mm	1/4"





**SINGLE BANJO BODY  
METRIC MALE**

1410

PART NUMBER	TUBE OD	TO SUIT THREAD
A5500-03M5	3 mm	M5
A5500-03M6	3 mm	M6
A5500-04M5	4 mm	M5
A5500-04M6	4 mm	M6
A5500-05M5	5 mm	M5
A5500-05M6	5 mm	M6
A5500-06M5	6 mm	M5
A5500-06M6	6 mm	M6

**BSPT MALE**

A5500-0418	4 mm	1/8" BSPT
A5500-0518	5 mm	1/8" BSPT
A5500-0514	5 mm	1/4" BSPT
A5500-0618	6 mm	1/8" BSPT
A5500-0614	6 mm	1/4" BSPT
A5500-0818	8 mm	1/8" BSPT
A5500-0814	8 mm	1/4" BSPT
A5500-0838	8 mm	3/8" BSPT
A5500-1014	10 mm	1/4" BSPT
A5500-1038	10 mm	3/8" BSPT
A5500-1238	12 mm	3/8" BSPT
A5500-1212	12 mm	1/2" BSPT
A5500-1412	14 mm	1/2" BSPT



**SWIVEL SINGLE BANJO BODY  
METRIC MALE**

1410

PART NUMBER	TUBE OD	THREAD
A5550-03M5	3 mm	M5
A5550-04M5	4 mm	M5
A5550-05M5	5 mm	M5
A5550-06M5	6 mm	M5

**BSPT MALE**

A5550-0418	4 mm	1/8" BSPT
A5550-0518	5 mm	1/8" BSPT
A5550-0514	5 mm	1/4" BSPT
A5550-0618	6 mm	1/8" BSPT
A5550-0614	6 mm	1/4" BSPT
A5550-0818	8 mm	1/8" BSPT
A5550-0814	8 mm	1/4" BSPT
A5550-0838	8 mm	3/8" BSPT
A5550-1014	10 mm	1/4" BSPT
A5550-1038	10 mm	3/8" BSPT
A5550-1238	12 mm	3/8" BSPT



**DOUBLE BANJO BODY  
METRIC MALE**

1410

PART NUMBER	TUBE OD	TO SUIT THREAD
A5510-04M5	4 mm	M5
A5510-04M6	4 mm	M6

**BSPT MALE**

A5510-0418	4 mm	1/8" BSPT
A5510-0518	5 mm	1/8" BSPT
A5510-0514	5 mm	1/4" BSPT
A5510-0618	6 mm	1/8" BSPT
A5510-0614	6 mm	1/4" BSPT
A5510-0818	8 mm	1/8" BSPT
A5510-0814	8 mm	1/4" BSPT



**SWIVEL DOUBLE BANJO BODY  
METRIC MALE**

1410

PART NUMBER	TUBE OD	THREAD
A5560-04M5	4 mm	M5

**BSPT MALE**

A5560-0418	4 mm	1/8" BSPT
A5560-0518	5 mm	1/8" BSPT
A5560-0514	5 mm	1/4" BSPT
A5560-0618	6 mm	1/8" BSPT
A5560-0614	6 mm	1/4" BSPT
A5560-0818	8 mm	1/8" BSPT
A5560-0814	8 mm	1/4" BSPT



**BIDIRECTIONAL FLOW  
MANUAL REGULATOR  
METRIC MALE**

1410

PART NUMBER	TUBE OD	THREAD
A5925-03M5	3 mm	M5
A5925-04M5	4 mm	M5
A5925-05M5	5 mm	M5
A5925-06M5	6 mm	M5

**BSPT MALE**

A5925-0418	4 mm	1/8" BSPT
A5925-0518	5 mm	1/8" BSPT
A5925-0514	5 mm	1/4" BSPT
A5925-0618	6 mm	1/8" BSPT
A5925-0614	6 mm	1/4" BSPT
A5925-0818	8 mm	1/8" BSPT
A5925-0814	8 mm	1/4" BSPT
A5925-0838	8 mm	3/8" BSPT
A5925-1014	10 mm	1/4" BSPT
A5925-1038	10 mm	3/8" BSPT
A5925-1238	12 mm	3/8" BSPT
A5925-1212	12 mm	1/2" BSPT
A5925-1412	14 mm	1/2" BSPT

Do you also need?



**Banjo bolts**

Find it on page 580, section nine

# Aignep High Pressure Push-In Fittings

The Aignep high-pressure series is designed specifically for centralised lubrication systems, including oil and grease. It can operate at pressures up to 150 bar and resist strong vibrations. Various threads are available for secure sealing and connection.

### Main Advantages

- Quick connection and disconnection
- Full flow
- 3 threads available: BSPP, BSPT and Metric
- Metric-specific threads
- Robust and resistant
- Range of temperature / high pressure

### Applications

- Lubrication systems
- Heavy industry, railways
- Vehicles (truck, bus, farming)

### Threads

Tapered gas in conformity with ISO 7.1, BS 21, DIN 2999.  
Metric tapered in conformity with UNI 7707.

### Fluids

Oil, water, grease. \*Compressed air.

### Connection Tubes

Plastic tubes: PA6, PA66 for high pressure.  
\*PA6, PA11, PA12, polyethylene, polyurethane, braided PVC.



### SPECIFICATIONS

Pressure range – fluids	0 bar to 150 bar (0 to 15 MPa)
– compressed air	*0 bar to 30 bar (0 to 3 MPa)
Temperature range	-30°C to +130°C

### MATERIALS

Body	Nickel plated brass
Collet	Nickel plated brass
Seal	HNBR O-ring



**STRAIGHT ADAPTOR  
METRIC MALE**

1410

PART NUMBER	TUBE OD	THREAD
A58000-04M6	4 mm	M6 x 1
A58000-04M8	4 mm	M8 x 1
A58000-04M10	4 mm	M10 x 1
A58000-06M6	6 mm	M6 x 1
A58000-06M8	6 mm	M8 x 1
A58000-06M10	6 mm	M10 x 1

### BSPT MALE

A58000-0418	4 mm	1/8" BSPT
A58000-0618	6 mm	1/8" BSPT



**ELBOW  
METRIC MALE**

1410

PART NUMBER	TUBE OD	THREAD
A58100-04M6	4 mm	M6 x 1
A58100-04M8	4 mm	M8 x 1
A58100-04M10	4 mm	M10 x 1
A58100-06M6	6 mm	M6 x 1
A58100-06M8	6 mm	M8 x 1
A58100-06M10	6 mm	M10 x 1

### BSPT MALE

A58100-0418	4 mm	1/8" BSPT
A58100-0618	6 mm	1/8" BSPT



**STRAIGHT CONNECTOR  
TUBE TO TUBE**

1410

PART NUMBER	TUBE OD
A58040-04	4 mm
A58040-06	6 mm

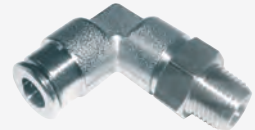

**SWIVEL ELBOW  
METRIC MALE**

1410

PART NUMBER	TUBE OD	THREAD
A58111-04M6	4 mm	M6 x 1
A58111-04M8	4 mm	M8 x 1
A58111-04M10	4 mm	M10 x 1
A58111-06M6	6 mm	M6 x 1
A58111-06M8	6 mm	M8 x 1
A58111-06M10	6 mm	M10 x 1

### BSPT MALE

A58111-0418	4 mm	1/8" BSPT
A58111-0618	6 mm	1/8" BSPT

# Aignep Swift-Fit Fittings

Aigneps Swift Fit Series is designed for heavy-duty usage & is an all-metal, robust, high-performing solution. It is ideal for use in environments with strong vibrations, abrasions, and welding sparks. The line is purposely manufactured to connect with inch-sized tubes, ensuring a perfect fit.

## Main Advantages

- Quick connection and disconnection
- Full flow and vacuum resistant tank to special shaped seals
- BSPT (universal short) NPTF
- Robust and resistant
- Large range to satisfy extreme applications
- EPDM (-40°C) version on demand
- Silicon free

## Applications

- Robotics
- Automotive welding
- Cooling water, vacuum
- Heavy industry, railways
- Compressed air circuit
- Glycol with EPDM

## Features / Benefits

- No stripped fittings or ports
- Quick installation
- Reduce inventory
- Completely reusable
- No pitch identification

## Suitability

Compressed air, water

## Connection Tubes

Nylon, polyethylene, \*polyurethane, copper.  
A minimum hardness of 98 shore is required.



## SPECIFICATIONS

Pressure range	Vacuum to 17 bar
Temperature range	-20°C to +80°C
Torque min, max	5 Nm (3.7 ft lb), 7 Nm (5.2 ft lb)
Media	Compressed air, water

## MATERIALS

Body, thrust ring & sleeve	Nickel plated brass
Gripper collet	Stainless steel
Safety ring	Technopolymer
Lip seal & thread seal	NBR 70

## STRAIGHT ADAPTOR UNIVERSAL MALE



PART NUMBER	TUBE OD	THREAD*
A89000-1818	1/8"	1/8"
A89000-1814	1/8"	1/4"
A89000-53218	5/32"	1/8"
A89000-53214	5/32"	1/4"
A89000-1418	1/4"	1/8"
A89000-1414	1/4"	1/4"
A89000-1438	1/4"	3/8"
A89000-51618	5/16"	1/8"
A89000-51614	5/16"	1/4"
A89000-51638	5/16"	3/8"
A89000-3818	3/8"	1/8"
A89000-3814	3/8"	1/4"
A89000-3838	3/8"	3/8"
A89000-3812	3/8"	1/2"
A89000-1214	1/2"	1/4"
A89000-1238	1/2"	3/8"
A89000-1212	1/2"	1/2"

\*Can be used on BSPP, BSPT, NPT threads

## STRAIGHT ADAPTOR NPTF FEMALE

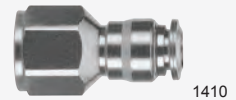

PART NUMBER	TUBE OD	THREAD
A89030-1818	1/8"	1/8" NPTF
A89030-1814	1/8"	1/4" NPTF
A89030-53218	5/32"	1/8" NPTF
A89030-53214	5/32"	1/4" NPTF
A89030-1418	1/4"	1/8" NPTF
A89030-1414	1/4"	1/4" NPTF
A89030-3814	3/8"	1/4" NPTF
A89030-3838	3/8"	3/8" NPTF

## STRAIGHT CONNECTOR

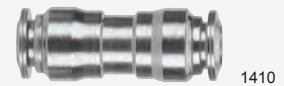

PART NUMBER	TUBE OD	TUBE OD
A89040-18	1/8"	1/8"
A89040-14532	1/4"	5/32"
A89040-14	1/4"	1/4"
A89040-3814	3/8"	1/4"
A89040-3812	3/8"	1/2"
A89040-38	3/8"	3/8"
A89040-12	1/2"	1/2"



# SWIFT-FIT – UNIVERSAL IMPERIAL PUSH-IN FITTINGS 89000 SERIES



**TUBE REDUCER**

1410

PART NUMBER	TUBE OD	TUBE OD
A89700-1418	1/4"	1/8"
A89700-14532	1/4"	5/32"
A89700-3814	3/8"	1/4"
A89700-1214	1/2"	1/4"
A89700-1238	1/2"	3/8"

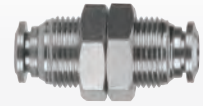

**BULKHEAD  
UNIVERSAL TUBE TO TUBE**

1410

PART NUMBER	TUBE OD
A89050-18M10	1/8"
A89050-14M14	1/4"
A89050-38M20	3/8"
A89050-12M22	1/2"



**ELBOW  
TUBE TO TUBE**

1410

PART NUMBER	TUBE OD
A89130-18	1/8"
A89130-14	1/4"
A89130-38	3/8"
A89130-12	1/2"



**SWIVEL BRANCH TEE  
UNIVERSAL MALE**

1410

PART NUMBER	TUBE OD	THREAD*
A89211-1818	1/8"	1/8"
A89211-1814	1/8"	1/4"
A89211-53218	5/32"	1/8"
A89211-53214	5/32"	1/4"
A89211-1418	1/4"	1/8"
A89211-1414	1/4"	1/4"
A89211-1438	1/4"	3/8"
A89211-3818	3/8"	1/8"
A89211-3814	3/8"	1/4"
A89211-3838	3/8"	3/8"
A89211-3812	3/8"	1/2"
A89211-1214	1/2"	1/4"
A89211-1238	1/2"	3/8"
A89211-1212	1/2"	1/2"

\*Can be used on BSP, BSPT, NPT threads



**SWIVEL ELBOW  
NPTF FEMALE**

1410

PART NUMBER	TUBE OD	THREAD
A89106-53218	5/32"	1/8" NPTF
A89106-53214	5/32"	1/4" NPTF
A89106-1418	1/4"	1/8" NPTF
A89106-1414	1/4"	1/4" NPTF
A89106-3818	3/8"	1/8" NPTF
A89106-3814	3/8"	1/4" NPTF



**UNION TEE  
TUBE TO TUBE**

1410

PART NUMBER	TUBE OD
A89230-18	1/8"
A89230-14	1/4"
A89230-38	3/8"
A89230-12	1/2"



**SWIVEL ELBOW  
UNIVERSAL MALE**

1410

PART NUMBER	TUBE OD	THREAD*
A89111-1818	1/8"	1/8"
A89111-1814	1/8"	1/4"
A89111-53218	5/32"	1/8"
A89111-53214	5/32"	1/4"
A89111-1418	1/4"	1/8"
A89111-1414	1/4"	1/4"
A89111-1438	1/4"	3/8"
A89111-51618	5/16"	1/8"
A89111-51614	5/16"	1/4"
A89111-51638	5/16"	3/8"
A89111-3818	3/8"	1/8"
A89111-3814	3/8"	1/4"
A89111-3838	3/8"	3/8"
A89111-3812	3/8"	1/2"
A89111-1214	1/2"	1/4"
A89111-1238	1/2"	3/8"
A89111-1212	1/2"	1/2"

\*Can be used on BSPP, BSPT, NPT threads



**SWIVEL RUN TEE  
UNIVERSAL MALE**

1410

PART NUMBER	TUBE OD	THREAD*
A89223-1818	1/8"	1/8"
A89223-1814	1/8"	1/4"
A89223-53218	5/32"	1/8"
A89223-53214	5/32"	1/4"
A89223-1418	1/4"	1/8"
A89223-1414	1/4"	1/4"
A89223-1438	1/4"	3/8"
A89223-3818	3/8"	1/8"
A89223-3814	3/8"	1/4"
A89223-3838	3/8"	3/8"
A89223-3812	3/8"	1/2"
A89223-1214	1/2"	1/4"
A89223-1238	1/2"	3/8"
A89223-1212	1/2"	1/2"

\*Can be used on BSPP, BSPT, NPT threads

# Aignep Food Quality Push-In Fittings

- NSF 169 certified to comply with food standards
- Brass lined with food grade coating
- Can be used in aggressive environments due to the special coating

### Threads

Parallel gas in conformity with ISO 228 Class A.  
Metric in conformity with ISO R/262.

### Advantages

- NSF 169
- Quick connection and disconnection
- Full flow and vacuum resistant thanks to special shaped seals
- Silicone free

### Applications

Dairy, coffee machine, vending, food & beverage, medical, vacuum

### Connection Tubes

Plastic tubes: PA6, PA11, PA12, PTFE polyethylene, \*polyurethane, etc.  
\*For polyurethane hoses, a minimum hardness of 98 shore is required.

### Applicable Standards

Certified to NSF/ANSI 51



### SPECIFICATIONS

Pressure range	-0.99 bar to 20 bar (-0.099 to 2.0 MPa)
Temperature range	-15°C to +190°C

### MATERIALS

Body, collet & capsule	Food grade nickel plated brass
Clamping washer	301 stainless steel
Safety ring	PTFE
O-ring & thread packing	Food grade FKM

### STRAIGHT ADAPTOR METRIC MALE



PART NUMBER	TUBE OD	THREAD
A70020-04M5	4 mm	M5

### BSPP MALE

A70020-0418	4 mm	1/8" BSPP
A70020-0618	6 mm	1/8" BSPP
A70020-0614	6 mm	1/4" BSPP
A70020-0818	8 mm	1/8" BSPP
A70020-0814	8 mm	1/4" BSPP
A70020-1014	10 mm	1/4" BSPP
A70020-1038	10 mm	3/8" BSPP
A70020-1238	12 mm	3/8" BSPP

### STRAIGHT ADAPTOR TUBE TO TUBE



PART NUMBER	TUBE OD
A70040-04	4 mm
A70040-06	6 mm
A70040-08	8 mm
A70040-10	10 mm
A70040-12	12 mm

### SWIVEL ELBOW METRIC MALE



PART NUMBER	TUBE OD	THREAD
A70116-04M5	4 mm	M5

### BSPP MALE

A70116-0418	4 mm	1/8" BSPP
A70116-0618	6 mm	1/8" BSPP
A70116-0614	6 mm	1/4" BSPP
A70116-0818	8 mm	1/8" BSPP
A70116-0814	8 mm	1/4" BSPP
A70116-1014	10 mm	1/4" BSPP
A70116-1038	10 mm	3/8" BSPP
A70116-1238	12 mm	3/8" BSPP

### SWIVEL CENTRE LEG TEE BSPP MALE



PART NUMBER	TUBE OD	THREAD
A70216-0418	4 mm	1/8" BSPP
A70216-0618	6 mm	1/8" BSPP
A70216-0614	6 mm	1/4" BSPP
A70216-0818	8 mm	1/8" BSPP
A70216-0814	8 mm	1/4" BSPP

### TEE TUBE TO TUBE



PART NUMBER	TUBE OD
A70230-04	4 mm
A70230-06	6 mm
A70230-08	8 mm
A70230-10	10 mm
A70230-12	12 mm





# Festo Fittings

Pneumatic fittings play a crucial role in pneumatic connection technology. Festo provides a wide range of fittings on the following pages, including push-in or threaded fittings made from pure polymer or stainless steel, offering maximum corrosion and chemical resistance.

Festo pneumatic push-in fittings are an industry leader known for their innovative quick-release function by pressing a releasing ring. These fittings work with standard OD tubing that is widely available.

Festo provides various fittings and tubing specific to individual applications for optimal performance with minimal leaks. Pairing Festo fittings with their tubing is recommended to ensure the best results.

## Specifications

Pressure range: 0.95 to +14 bar  
Temperature range: -10°C to 80°C

## Push-in fitting QS series

- Standard series
- Wide range of variants: standard, mini size, metal, stainless steel, flame retardant with R and G metric thread
- PBT and nickel plated brass

## Push-in fitting, QSM mini series

- Mini series
- Wide range of variants: standard, mini size, metal, stainless steel, flame retardant with R and G metric thread
- Compact for maximum component density in confined installation spaces
- PBT and nickel plated brass

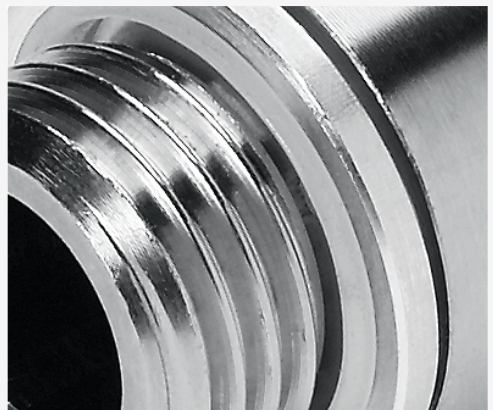





**QS SERIES QUICK STAR – STANDARD PUSH-IN FITTINGS**

**FEATURES**

- Simple & reliable connection & release
- Wide range of variants: standard, mini size, metal, stainless steel, flame retardant with R & G metric thread
- Types in accordance with ATEX directive for potentially explosive atmospheres

**SPECIFICATIONS**

Pressure range (bar)	-0.95 to +14
Temperature range	-10°C to +80°C

**MATERIALS**

Release ring	Polyacetate
Seal	NBR
Body	Polybutene terephthalate, nickel plated brass
Tube retaining claw	High alloy stainless steel
Threaded coupling	Nickel plated brass

**STRAIGHT  
BSPT MALE WITH EXTERNAL HEX  
SOLD IN PACKS OF 10**



3130

PART NUMBER	TYPE	THREAD	TUBE OD
FES153001	QS-1/8-4	1/8" BSPT	4 mm
FES153002	QS-1/8-6	1/8" BSPT	6 mm
FES153004	QS-1/8-8	1/8" BSPT	8 mm
FES190643	QS-1/8-10	1/8" BSPT	10 mm
FES190644	QS-1/4-4	1/4" BSPT	4 mm
FES153003	QS-1/4-6	1/4" BSPT	6 mm
FES153005	QS-1/4-8	1/4" BSPT	8 mm
FES153007	QS-1/4-10	1/4" BSPT	10 mm
FES164980	QS-1/4-12	1/4" BSPT	12 mm
FES190645	QS-3/8-6	3/8" BSPT	6 mm
FES153006	QS-3/8-8	3/8" BSPT	8 mm
FES153008	QS-3/8-10	3/8" BSPT	10 mm
FES153009	QS-3/8-12	3/8" BSPT	12 mm
FES164957	QS-3/8-16	3/8" BSPT	16 mm
FES190646	QS-1/2-10	1/2" BSPT	10 mm
FES153010	QS-1/2-12	1/2" BSPT	12 mm
FES153011	QS-1/2-16	1/2" BSPT	16 mm

Image shown with BSPT male thread



3130

**STRAIGHT  
BSPP MALE WITH EXTERNAL HEX  
SOLD IN PACKS OF 10**

PART NUMBER	TYPE	THREAD	TUBE OD
FES186095	QS-G1/8-4	1/8" BSPP	4 mm
FES186096	QS-G1/8-6	1/8" BSPP	6 mm
FES186098	QS-G1/8-8	1/8" BSPP	8 mm
FES186097	QS-G1/4-6	1/4" BSPP	6 mm
FES186099	QS-G1/4-8	1/4" BSPP	8 mm
FES186101	QS-G1/4-10	1/4" BSPP	10 mm
FES186350	QS-G1/4-12	1/4" BSPP	12 mm
FES186100	QS-G3/8-8	3/8" BSPP	8 mm
FES186102	QS-G3/8-10	3/8" BSPP	10 mm
FES186103	QS-G3/8-12	3/8" BSPP	12 mm
FES186347	QS-G3/8-16	3/8" BSPP	16 mm
FES186104	QS-G1/2-12	1/2" BSPP	12 mm
FES186105	QS-G1/2-16	1/2" BSPP	16 mm

**EQUAL STRAIGHT  
SOLD IN PACKS OF 10**



3130

PART NUMBER	TYPE	TUBE OD
FES153031	QS-4	4 mm
FES153032	QS-6	6 mm
FES153033	QS-8	8 mm
FES153034	QS-10	10 mm
FES153035	QS-12	12 mm
FES153036	QS-16	16 mm

**REDUCING STRAIGHT  
SOLD IN PACKS OF 10**



3130

PART NUMBER	TYPE	TUBE OD	TUBE OD
FES153037	QS-6-4	6 mm	4 mm
FES130606	QS-8-4	8 mm	4 mm
FES153038	QS-8-6	8 mm	6 mm
FES130607	QS-10-6	10 mm	6 mm
FES153039	QS-10-8	10 mm	8 mm
FES130608	QS-12-8	12 mm	8 mm
FES153040	QS-12-10	12 mm	10 mm

**REDUCING STRAIGHT  
PUSH-IN SLEEVE / PUSH-IN CONNECTOR  
SOLD IN PACKS OF 10**



3130

PART NUMBER	TYPE	TUBE OD	TUBE OD
FES153041	QS-6H-4	6 mm	4 mm
FES130622	QS-8H-4	8 mm	4 mm
FES153042	QS-8H-6	8 mm	6 mm
FES130623	QS-10H-6	10 mm	6 mm
FES153043	QS-10H-8	10 mm	8 mm
FES132981	QS-12H-6	12 mm	6 mm
FES130624	QS-12H-8	12 mm	8 mm
FES153044	QS-12H-10	12 mm	10 mm

**STRAIGHT  
BSPT MALE WITH INTERNAL HEX  
SOLD IN PACKS OF 10**



3130

PART NUMBER	TYPE	THREAD	TUBE OD
FES153012	QS-1/8-4-I	1/8" BSPT	4 mm
FES153013	QS-1/8-6-I	1/8" BSPT	6 mm
FES153015	QS-1/8-8-I	1/8" BSPT	8 mm
FES190647	QS-1/8-10-I	1/8" BSPT	10 mm
FES153014	QS-1/4-6-I	1/4" BSPT	6 mm
FES153016	QS-1/4-8-I	1/4" BSPT	8 mm
FES153018	QS-1/4-10-I	1/4" BSPT	10 mm
FES190649	QS-1/4-12-I	1/4" BSPT	12 mm
FES153017	QS-3/8-8-I	3/8" BSPT	8 mm
FES153019	QS-3/8-10-I	3/8" BSPT	10 mm
FES153020	QS-3/8-12-I	3/8" BSPT	12 mm
FES190648	QS-1/2-10-I	1/2" BSPT	10 mm
FES153021	QS-1/2-12-I	1/2" BSPT	12 mm



QS SERIES QUICK STAR – STANDARD PUSH-IN FITTINGS

STRAIGHT  
BSPP MALE WITH INTERNAL HEX  
SOLD IN PACKS OF 10



3130

PART NUMBER	TYPE	THREAD	TUBE OD
FES186106	QS-G1/8-4-I	1/8" BSPP	4 mm
FES186107	QS-G1/8-6-I	1/8" BSPP	6 mm
FES186109	QS-G1/8-8-I	1/8" BSPP	8 mm
FES132999	QS-G1/8-10-I	1/8" BSPP	10 mm
FES186108	QS-G1/4-6-I	1/4" BSPP	6 mm
FES186110	QS-G1/4-8-I	1/4" BSPP	8 mm
FES186112	QS-G1/4-10-I	1/4" BSPP	10 mm
FES186111	QS-G3/8-8-I	3/8" BSPP	8 mm
FES186113	QS-G3/8-10-I	3/8" BSPP	10 mm
FES186114	QS-G3/8-12-I	3/8" BSPP	12 mm
FES186115	QS-G1/2-12-I	1/2" BSPP	12 mm

EQUAL ELBOW  
SOLD IN PACKS OF 10



3130

PART NUMBER	TYPE	TUBE OD
FES153070	QSL-4	4 mm
FES153071	QSL-6	6 mm
FES153072	QSL-8	8 mm
FES153073	QSL-10	10 mm
FES153074	QSL-12	12 mm
FES153075	QSL-16	16 mm

360° SWIVEL ELBOW  
BSPT MALE WITH EXTERNAL HEX  
SOLD IN PACKS OF 10



3130

PART NUMBER	TYPE	THREAD	TUBE OD
FES153045	QSL-1/8-4	1/8" BSPT	4 mm
FES153046	QSL-1/8-6	1/8" BSPT	6 mm
FES153048	QSL-1/8-8	1/8" BSPT	8 mm
FES190658	QSL-1/8-10	1/8" BSPT	10 mm
FES190659	QSL-1/4-4	1/4" BSPT	4 mm
FES153047	QSL-1/4-6	1/4" BSPT	6 mm
FES153049	QSL-1/4-8	1/4" BSPT	8 mm
FES153051	QSL-1/4-10	1/4" BSPT	10 mm
FES164981	QSL-1/4-12	1/4" BSPT	12 mm
FES190660	QSL-3/8-6	3/8" BSPT	6 mm
FES153050	QSL-3/8-8	3/8" BSPT	8 mm
FES153052	QSL-3/8-10	3/8" BSPT	10 mm
FES153053	QSL-3/8-12	3/8" BSPT	12 mm
FES164958	QSL-3/8-16	3/8" BSPT	16 mm
FES190661	QSL-1/2-10	1/2" BSPT	10 mm
FES153054	QSL-1/2-12	1/2" BSPT	12 mm
FES153055	QSL-1/2-16	1/2" BSPT	16 mm

360° SWIVEL ELBOW  
BSPP FEMALE WITH EXTERNAL HEX  
SOLD IN PACKS OF 10



3130

PART NUMBER	TYPE	THREAD	TUBE OD
FES153273	QSLF-1/8-4-B	1/8" BSPP	4 mm
FES153274	QSLF-1/8-6-B	1/8" BSPP	6 mm
FES153276	QSLF-1/8-8-B	1/8" BSPP	8 mm
FES153275	QSLF-1/4-6-B	1/4" BSPP	6 mm
FES153277	QSLF-1/4-8-B	1/4" BSPP	8 mm
FES153279	QSLF-1/4-10-B	1/4" BSPP	10 mm
FES153278	QSLF-3/8-8-B	3/8" BSPP	8 mm
FES153280	QSLF-3/8-10-B	3/8" BSPP	10 mm

360° SWIVEL ELBOW  
BSPP MALE WITH EXTERNAL HEX  
SOLD IN PACKS OF 10



3130

PART NUMBER	TYPE	THREAD	TUBE OD
FES186116	QSL-G1/8-4	1/8" BSPP	4 mm
FES186117	QSL-G1/8-6	1/8" BSPP	6 mm
FES186119	QSL-G1/8-8	1/8" BSPP	8 mm
FES186118	QSL-G1/4-6	1/4" BSPP	6 mm
FES186120	QSL-G1/4-8	1/4" BSPP	8 mm
FES186122	QSL-G1/4-10	1/4" BSPP	10 mm
FES186351	QSL-G1/4-12	1/4" BSPP	12 mm
FES186121	QSL-G3/8-8	3/8" BSPP	8 mm
FES186123	QSL-G3/8-10	3/8" BSPP	10 mm
FES186124	QSL-G3/8-12	3/8" BSPP	12 mm
FES186348	QSL-G3/8-16	3/8" BSPP	16 mm
FES186125	QSL-G1/2-12	1/2" BSPP	12 mm
FES186126	QSL-G1/2-16	1/2" BSPP	16 mm

SINGLE BANJO CONNECTOR  
BSPT MALE WITH EXTERNAL HEX  
SOLD IN PACKS OF 10



3130

PART NUMBER	TYPE	THREAD	TUBE OD
FES153086	QSLV-1/8-4	1/8" BSPT	4 mm
FES153087	QSLV-1/8-6	1/8" BSPT	6 mm
FES153089	QSLV-1/8-8	1/8" BSPT	8 mm
FES153088	QSLV-1/4-6	1/4" BSPT	6 mm
FES153090	QSLV-1/4-8	1/4" BSPT	8 mm
FES153092	QSLV-1/4-10	1/4" BSPT	10 mm
FES153091	QSLV-3/8-8	3/8" BSPT	8 mm
FES153093	QSLV-3/8-10	3/8" BSPT	10 mm
FES153094	QSLV-3/8-12	3/8" BSPT	12 mm
FES153095	QSLV-1/2-12	1/2" BSPT	12 mm
FES153096	QSLV-1/2-16	1/2" BSPT	16 mm

SINGLE BANJO CONNECTOR  
METRIC MALE WITH EXTERNAL HEX  
SOLD IN PACKS OF 10



3130

PART NUMBER	TYPE	THREAD	TUBE OD
FES190666	QSLV-M5-6	M5	6 mm

BSPP MALE WITH EXTERNAL HEX

FES186137	QSLV-G1/8-4	1/8" BSPP	4 mm
FES186138	QSLV-G1/8-6	1/8" BSPP	6 mm
FES186140	QSLV-G1/8-8	1/8" BSPP	8 mm
FES186139	QSLV-G1/4-6	1/4" BSPP	6 mm
FES186141	QSLV-G1/4-8	1/4" BSPP	8 mm
FES186143	QSLV-G1/4-10	1/4" BSPP	10 mm
FES186142	QSLV-G3/8-8	3/8" BSPP	8 mm
FES186144	QSLV-G3/8-10	3/8" BSPP	10 mm
FES186145	QSLV-G3/8-12	3/8" BSPP	12 mm
FES186146	QSLV-G1/2-12	1/2" BSPP	12 mm
FES186147	QSLV-G1/2-16	1/2" BSPP	16 mm



QS SERIES QUICK STAR – STANDARD PUSH-IN FITTINGS

360° SWIVEL TEE  
BSPT MALE WITH EXTERNAL HEX  
SOLD IN PACKS OF 10



3130

PART NUMBER	TYPE	THREAD	TUBE OD
FES153106	QST-1/8-4	1/8" BSPT	4 mm
FES153107	QST-1/8-6	1/8" BSPT	6 mm
FES153109	QST-1/8-8	1/8" BSPT	8 mm
FES190667	QST-1/8-10	1/8" BSPT	10 mm
FES190668	QST-1/4-4	1/4" BSPT	4 mm
FES153108	QST-1/4-6	1/4" BSPT	6 mm
FES153110	QST-1/4-8	1/4" BSPT	8 mm
FES153112	QST-1/4-10	1/4" BSPT	10 mm
FES190669	QST-1/4-12	1/4" BSPT	12 mm
FES190670	QST-3/8-6	3/8" BSPT	6 mm
FES153111	QST-3/8-8	3/8" BSPT	8 mm
FES153113	QST-3/8-10	3/8" BSPT	10 mm
FES153114	QST-3/8-12	3/8" BSPT	12 mm
FES164959	QST-3/8-16	3/8" BSPT	16 mm
FES190672	QST-1/2-10	1/2" BSPT	10 mm
FES153115	QST-1/2-12	1/2" BSPT	12 mm
FES153116	QST-1/2-16	1/2" BSPT	16 mm

STRAIGHT  
BSPP FEMALE WITH EXTERNAL HEX  
SOLD IN PACKS OF 10



3130

PART NUMBER	TYPE	THREAD	TUBE OD
FES153022	QSF-1/8-4-B	1/8" BSPP	4 mm
FES153023	QSF-1/8-6-B	1/8" BSPP	6 mm
FES153025	QSF-1/8-8-B	1/8" BSPP	8 mm
FES190650	QSF-1/4-4-B	1/4" BSPP	4 mm
FES153024	QSF-1/4-6-B	1/4" BSPP	6 mm
FES153026	QSF-1/4-8-B	1/4" BSPP	8 mm
FES153028	QSF-1/4-10-B	1/4" BSPP	10 mm
FES190651	QSF-1/4-12-B	1/4" BSPP	12 mm
FES190652	QSF-3/8-6-B	3/8" BSPP	6 mm
FES153027	QSF-3/8-8-B	3/8" BSPP	8 mm
FES153029	QSF-3/8-10-B	3/8" BSPP	10 mm
FES153030	QSF-3/8-12-B	3/8" BSPP	12 mm
FES190653	QSF-1/2-12-B	1/2" BSPP	12 mm
FES190654	QSF-1/2-16-B	1/2" BSPP	16 mm

EQUAL TEE  
SOLD IN PACKS OF 10



3130

PART NUMBER	TYPE	TUBE OD
FES153128	QST-4	4 mm
FES153129	QST-6	6 mm
FES153130	QST-8	8 mm
FES153131	QST-10	10 mm
FES153132	QST-12	12 mm
FES153133	QST-16	16 mm

EQUAL Y  
SOLD IN PACKS OF 10



3130

PART NUMBER	TYPE	TUBE OD
FES153148	QSY-4	4 mm
FES153149	QSY-6	6 mm
FES153150	QSY-8	8 mm
FES153151	QSY-10	10 mm
FES153152	QSY-12	12 mm
FES130609	QSY-16	16 mm

REDUCING TEE  
SOLD IN PACKS OF 10



3130

PART NUMBER	TYPE	TUBE OD	TUBE OD
FES153134	QST-6-4	6 mm	4 mm
FES130613	QST-8-4	8 mm	4 mm
FES153135	QST-8-6	8 mm	8 mm
FES130614	QST-10-6	10 mm	6 mm
FES153136	QST-10-8	10 mm	8 mm
FES130615	QST-12-8	12 mm	8 mm
FES153137	QST-12-10	12 mm	10 mm
FES130616	QST-16-12	16 mm	12 mm

REDUCING Y  
SOLD IN PACKS OF 10



3130

PART NUMBER	TYPE	TUBE OD	TUBE OD
FES190673	QSY-M5-4	M5	4 mm
FES190674	QSY-M5-6	M5	6 mm
FES153153	QSY-6-4	6 mm	4 mm
FES130610	QSY-8-4	8 mm	4 mm
FES153154	QSY-8-6	8 mm	6 mm
FES130611	QSY-10-6	10 mm	6 mm
FES153155	QSY-10-8	10 mm	8 mm
FES130612	QSY-12-8	12 mm	8 mm
FES153156	QSY-12-10	12 mm	10 mm
FES190708	QSY-16-12	16 mm	12 mm

BLANKING PLUG  
SOLD IN PACKS OF 10



3130

PART NUMBER	TYPE	TUBE OD
FES153267	QSC-4H	4 mm
FES153268	QSC-6H	6 mm
FES153269	QSC-8H	8 mm
FES153270	QSC-10H	10 mm
FES153271	QSC-12H	12 mm
FES153272	QSC-16H	16 mm

BULKHEAD CONNECTOR  
SOLD IN PACKS OF 10



3130

PART NUMBER	TYPE	TUBE OD
FES153157	QSS-4	4 mm
FES153158	QSS-6	6 mm
FES153159	QSS-8	8 mm
FES153160	QSS-10	10 mm
FES153161	QSS-12	12 mm

Eight



QS SERIES QUICK STAR – STANDARD PUSH-IN FITTINGS



PLUG IN ELBOW  
SOLD IN PACKS OF 10

3130

PART NUMBER	TYPE	TUBE OD	TUBE OD
FES153065	QSL-4HL	4 mm	4 mm
FES153066	QSL-6HL	6 mm	6 mm
FES153067	QSL-8HL	8 mm	8 mm
FES153068	QSL-10HL	10 mm	10 mm
FES153069	QSL-12HL	12 mm	12 mm



REDUCING PLUG IN ELBOW  
SOLD IN PACKS OF 10

3130

PART NUMBER	TYPE	TUBE OD	TUBE OD
FES153061	QSL-6H-4	6 mm	4 mm
FES153062	QSL-8H-6	8 mm	6 mm
FES153063	QSL-10H-8	10 mm	8 mm
FES153064	QSL-12H-10	12 mm	10 mm



EXTENDED ELBOW  
BSPT MALE  
SOLD IN PACKS OF 10

3130

PART NUMBER	TYPE	THREAD	TUBE OD
FES153076	QSL-1/8-4	1/8" BSPT	4 mm
FES153077	QSL-1/8-6	1/8" BSPT	6 mm
FES153079	QSL-1/8-8	1/8" BSPT	8 mm
FES190662	QSL-1/4-4	1/4" BSPT	4 mm
FES153078	QSL-1/4-6	1/4" BSPT	6 mm
FES153080	QSL-1/4-8	1/4" BSPT	8 mm
FES153082	QSL-1/4-10	1/4" BSPT	10 mm
FES190663	QSL-3/8-6	3/8" BSPT	6 mm
FES153081	QSL-3/8-8	3/8" BSPT	8 mm
FES153083	QSL-3/8-10	3/8" BSPT	10 mm
FES153084	QSL-3/8-12	3/8" BSPT	12 mm
FES190664	QSL-1/2-10	1/2" BSPT	10 mm
FES153085	QSL-1/2-12	1/2" BSPT	12 mm



RUN TEE  
BSPT MALE  
SOLD IN PACKS OF 10

3130

PART NUMBER	TYPE	THREAD	TUBE OD
FES153117	QSTL-1/8-4	1/8" BSPT	4 mm
FES153118	QSTL-1/8-6	1/8" BSPT	6 mm
FES153120	QSTL-1/8-8	1/8" BSPT	8 mm
FES153119	QSTL-1/4-6	1/4" BSPT	6 mm
FES153121	QSTL-1/4-8	1/4" BSPT	8 mm
FES153123	QSTL-1/4-10	1/4" BSPT	10 mm
FES153122	QSTL-3/8-8	3/8" BSPT	8 mm
FES153124	QSTL-3/8-10	3/8" BSPT	10 mm
FES153125	QSTL-3/8-12	3/8" BSPT	12 mm
FES153126	QSTL-1/2-12	1/2" BSPT	12 mm
FES153127	QSTL-1/2-16	1/2" BSPT	16 mm

Y  
BSPT MALE  
SOLD IN PACKS OF 10



3130

PART NUMBER	TYPE	THREAD	TUBE OD
FES153138	QSY-1/8-4	1/8" BSPT	4 mm
FES153139	QSY-1/8-6	1/8" BSPT	6 mm
FES153141	QSY-1/8-8	1/8" BSPT	8 mm
FES190675	QSY-1/4-4	1/4" BSPT	4 mm
FES153140	QSY-1/4-6	1/4" BSPT	6 mm
FES153142	QSY-1/4-8	1/4" BSPT	8 mm
FES153144	QSY-1/4-10	1/4" BSPT	10 mm
FES153143	QSY-3/8-8	3/8" BSPT	8 mm
FES153145	QSY-3/8-10	3/8" BSPT	10 mm
FES153146	QSY-3/8-12	3/8" BSPT	12 mm
FES153147	QSY-1/2-12	1/2" BSPT	12 mm

90° PUSH IN Y ELBOW  
BSPT MALE  
SOLD IN PACKS OF 10



3130

PART NUMBER	TYPE	THREAD	TUBE OD
FES153172	QSYL-1/8-4	1/8" BSPT	4 mm
FES153173	QSYL-1/8-6	1/8" BSPT	6 mm
FES153175	QSYL-1/8-8	1/8" BSPT	8 mm
FES153174	QSYL-1/4-6	1/4" BSPT	6 mm
FES153176	QSYL-1/4-8	1/4" BSPT	8 mm
FES153178	QSYL-1/4-10	1/4" BSPT	10 mm
FES153177	QSYL-3/8-8	3/8" BSPT	8 mm
FES153179	QSYL-3/8-10	3/8" BSPT	10 mm
FES153180	QSYL-3/8-12	3/8" BSPT	12 mm
FES153181	QSYL-1/2-12	1/2" BSPT	12 mm

PUSH IN CAP  
SOLD IN PACKS OF 10



3130

PART NUMBER	TYPE	TUBE OD
FES153262	QSC-4	4 mm
FES153263	QSC-6	6 mm
FES153264	QSC-8	8 mm
FES153265	QSC-10	10 mm
FES153266	QSC-12	12 mm



QS SERIES QUICK STAR – STANDARD PUSH-IN FITTINGS



ONE-WAY FLOW CONTROL VALVE

3130

PART NUMBER	TYPE	TUBE OD
FES193965	GR-QS-3	3 mm
FES193967	GR-QS-4	4 mm
FES193969	GR-QS-6	6 mm
FES193970	GR-QS-8	8 mm



ONE-WAY FLOW CONTROL VALVE FOR EXHAUST AIR METRIC MALE

3130

PART NUMBER	TYPE	THREAD	TUBE OD
FES193137	GRLA-M5-QS-3-D	M5	3 mm
FES193138	GRLA-M5-QS-4-D	M5	4 mm
FES193139	GRLA-M5-QS-6-D	M5	6 mm

BSPP MALE

FES193142	GRLA-1/8-QS-3-D	1/8" BSPP	3 mm
FES193143	GRLA-1/8-QS-4-D	1/8" BSPP	4 mm
FES193144	GRLA-1/8-QS-6-D	1/8" BSPP	6 mm
FES193145	GRLA-1/8-QS-8-D	1/8" BSPP	8 mm
FES193146	GRLA-1/4-QS-6-D	1/4" BSPP	6 mm
FES193147	GRLA-1/4-QS-8-D	1/4" BSPP	8 mm
FES193148	GRLA-1/4-QS-10-D	1/4" BSPP	10 mm
FES193151	GRLA-3/8-QS-10-D	3/8" BSPP	10 mm
FES193149	GRLA-3/8-QS-6-D	3/8" BSPP	6 mm
FES193150	GRLA-3/8-QS-8-D	3/8" BSPP	8 mm
FES193152	GRLA-1/2-QS-12-D	1/2" BSPP	12 mm



ONE-WAY FLOW CONTROL VALVE FOR EXHAUST AIR METRIC MALE

3130

PART NUMBER	TYPE	THREAD	TUBE OD
FES197576	GRLA-M5-QS-3-RS-D	M5	3 mm
FES197577	GRLA-M5-QS-4-RS-D	M5	4 mm
FES197578	GRLA-M5-QS-6-RS-D	M5	6 mm

BSPP MALE

FES197579	GRLA-1/8-QS-3-RS-D	1/8"	3 mm
FES197580	GRLA-1/8-QS-4-RS-D	1/8"	4 mm
FES197581	GRLA-1/8-QS-6-RS-D	1/8"	6 mm
FES534337	GRLA-1/8-QS-8-RS-D	1/8"	8 mm
FES534338	GRLA-1/4-QS-6-RS-D	1/4"	6 mm
FES534339	GRLA-1/4-QS-8-RS-D	1/4"	8 mm
FES534340	GRLA-1/4-QS-10-RS-D	1/4"	10 mm
FES534343	GRLA-3/8-QS-10-RS-D	3/8"	10 mm
FES534341	GRLA-3/8-QS-6-RS-D	3/8"	6 mm
FES534342	GRLA-3/8-QS-8-RS-D	3/8"	8 mm
FES534344	GRLA-1/2-QS-12-RS-D	1/2"	12 mm

ONE-WAY FLOW CONTROL VALVE FOR EXHAUST AIR BSPP MALE



3130

PART NUMBER	TYPE	THREAD	TUBE OD
FES537075	GRLA-1/8-QS-6-MF-D	1/8"	6 mm
FES537076	GRLA-1/8-QS-8-MF-D	1/8"	8 mm

PILOTED CHECK VALVE METRIC MALE



3130

PART NUMBER	TYPE	THREAD
FES530029	HGL-M5-B	M5

BSPP MALE

FES530030	HGL-1/8-B	1/8" BSPP
FES530031	HGL-1/4-B	1/4" BSPP
FES530032	HGL-3/8-B	3/8" BSPP
FES530033	HGL-1/2-B	1/2" BSPP



3130

PILOTED CHECK VALVE METRIC MALE

PART NUMBER	TYPE	THREAD	TUBE OD
FES530038	HGL-M5-QS-4	M5	4 mm

BSPP MALE

FES530039	HGL-1/8-QS-4	1/8" BSPP	4 mm
FES530040	HGL-1/8-QS-6	1/8" BSPP	6 mm
FES530041	HGL-1/4-QS-8	1/4" BSPP	8 mm
FES530042	HGL-1/4-QS-10	1/4" BSPP	10 mm
FES530043	HGL-3/8-QS-8	3/8" BSPP	8 mm
FES530044	HGL-3/8-QS-10	3/8" BSPP	10 mm
FES530045	HGL-1/2-QS-12	1/2" BSPP	12 mm



ONE-WAY FLOW CONTROL VALVE BSPP MALE – FOR EXHAUST AIR



3130

PART NUMBER	TYPE	THREAD	TUBE OD
FES8068725	VFOE-LE-T-G18-Q4	1/8" BSPP	4 mm
FES8068726	VFOE-LE-T-G18-Q6	1/8" BSPP	6 mm
FES8068727	VFOE-LE-T-G18-Q8	1/8" BSPP	8 mm

BSPT MALE – FOR EXHAUST AIR

FES8068734	VFOE-LE-T-R18-Q4	1/8" BSPT	4 mm
FES8068735	VFOE-LE-T-R18-Q6	1/8" BSPT	6 mm
FES8068736	VFOE-LE-T-R18-Q8	1/8" BSPT	8 mm

BSPP MALE – FOR SUPPLY AIR

FES8068747	VFOE-LS-T-G18-Q4	1/8" BSPP	4 mm
FES8068748	VFOE-LS-T-G18-Q6	1/8" BSPP	6 mm
FES8068749	VFOE-LS-T-G18-Q8	1/8" BSPP	8 mm

BSPT MALE – FOR SUPPLY AIR

FES8068750	VFOE-LS-T-R18-Q4	1/8" BSPT	4 mm
FES8068751	VFOE-LS-T-R18-Q6	1/8" BSPT	6 mm
FES8068752	VFOE-LS-T-R18-Q8	1/8" BSPT	8 mm





QSM SERIES QUICK STAR – MINI PUSH-IN FITTINGS

FEATURES

- Simple & reliable connection & release
- Wide range of variants: standard, mini size, metal, stainless steel, flame retardant with R & G metric thread
- Types in accordance with ATEX directive for potentially explosive atmospheres

SPECIFICATIONS

Pressure range (bar)	-0.95 to +14
Temperature range	-10°C to +80°C

MATERIALS

Release ring	Polyacetate
Seal	NBR
Body	Polybuteneterephthalate, nickel plated brass
Tube retaining claw	High alloy stainless steel
Threaded coupling	Nickel plated brass

STRAIGHT  
METRIC MALE WITH EXTERNAL HEX  
SOLD IN PACKS OF 10



3130

PART NUMBER	TYPE	THREAD	TUBE OD
FES153301	QSM-M3-3	M3	3 mm
FES153303	QSM-M3-4	M3	4 mm
FES153302	QSM-M5-3	M5	3 mm
FES153304	QSM-M5-4	M5	4 mm
FES153306	QSM-M5-6	M5	6 mm
FES132600	QSM-M6-6	M6	6 mm

STRAIGHT  
SOLD IN PACKS OF 10



3130

PART NUMBER	TYPE	TUBE OD
FES153323	QSM-3	3 mm
FES153324	QSM-4	4 mm
FES153325	QSM-6	6 mm

STRAIGHT  
BSPT MALE WITH EXTERNAL HEX  
SOLD IN PACKS OF 10



3130

PART NUMBER	TYPE	THREAD	TUBE OD
FES153305	QSM-1/8-4	1/8" BSPT	4 mm
FES153307	QSM-1/8-6	1/8" BSPT	6 mm

REDUCING STRAIGHT  
SOLD IN PACKS OF 10



3130

PART NUMBER	TYPE	TUBE OD	TUBE OD
FES153326	QSM-4-3	4 mm	3 mm
FES153327	QSM-6-4	6 mm	4 mm

Image shown with BSPP male thread

STRAIGHT  
BSPT MALE WITH INTERNAL HEX  
SOLD IN PACKS OF 10



3130

PART NUMBER	TYPE	THREAD	TUBE OD
FES153316	QSM-1/8-4-I	1/8" BSPT	4 mm
FES153318	QSM-1/8-6-I	1/8" BSPT	6 mm

360° SWIVEL ELBOW  
METRIC MALE  
WITH EXTERNAL HEX  
SOLD IN PACKS OF 10



3130

PART NUMBER	TYPE	THREAD	TUBE OD
FES153330	QSML-M3-3	M3	3 mm
FES153332	QSML-M3-4	M3	4 mm
FES153331	QSML-M5-3	M5	3 mm
FES153333	QSML-M5-4	M5	4 mm
FES153335	QSML-M5-6	M5	6 mm
FES186352	QSML-M7-4	M7	4 mm
FES186353	QSML-M7-6	M7	6 mm

STRAIGHT  
BSPP MALE WITH INTERNAL HEX  
SOLD IN PACKS OF 10



3130

PART NUMBER	TYPE	THREAD	TUBE OD
FES186266	QSM-G1/8-4-I	1/8" BSPP	4 mm
FES186267	QSM-G1/8-6-I	1/8" BSPP	6 mm

Image shown with internal hex

360° SWIVEL ELBOW  
BSPT MALE  
WITH EXTERNAL HEX  
SOLD IN PACKS OF 10



3130

PART NUMBER	TYPE	THREAD	TUBE OD
FES153334	QSML-1/8-4	1/8" BSPT	4 mm
FES153336	QSML-1/8-6	1/8" BSPT	6 mm

STRAIGHT ROUND, RELEASE RING  
METRIC MALE WITH EXTERNAL HEX  
SOLD IN PACKS OF 10



3130

PART NUMBER	TYPE	THREAD	TUBE OD
FES133001	QSM-M3-3-I-R	M3	3 mm
FES133002	QSM-M3-4-I-R	M3	4 mm
FES133004	QSM-M5-4-I-R	M5	4 mm
FES133005	QSM-M5-6-I-R	M5	6 mm
FES133007	QSM-M7-6-I-R	M7	6 mm

360° SWIVEL ELBOW  
BSPP MALE  
SOLD IN PACKS OF 10



3130

PART NUMBER	TYPE	THREAD	TUBE OD
FES186268	QSML-G1/8-4	1/8" BSPP	4 mm
FES186269	QSML-G1/8-6	1/8" BSPP	6 mm





QSM SERIES QUICK STAR – MINI PUSH-IN FITTINGS

MINI PLUG-IN REDUCER  
SOLD IN PACKS OF 10



3130

PART NUMBER	TYPE	TUBE OD	TUBE OD
FES153328	QSM-4H-3	4 mm	3 mm
FES153329	QSM-6H-4	6 mm	4 mm

MINI PUSH-IN Y CONNECTOR  
SOLD IN PACKS OF 10



3130

PART NUMBER	TYPE	TUBE OD	TUBE OD
FES153373	QSMY-4-3	4 mm	3 mm
FES153374	QSMY-6-4	6 mm	4 mm

MINI HEX STUD  
BSPP MALE  
SOLD IN PACKS OF 10



3130

PART NUMBER	TYPE	THREAD	TUBE OD
FES186264	QSM-G1/8-4	1/8" BSPP	4 mm
FES186265	QSM-G1/8-6	1/8" BSPP	6 mm

MINI STUD WITH ROUND BODY  
METRIC MALE  
SOLD IN PACKS OF 10



3130

PART NUMBER	TYPE	THREAD	TUBE OD
FES153312	QSM-M3-3-I	M3	3 mm
FES153314	QSM-M3-4-I	M3	4 mm
FES153313	QSM-M5-3-I	M5	3 mm
FES153315	QSM-M5-4-I	M5	4 mm
FES153317	QSM-M5-6-I	M5	6 mm
FES153319	QSM-M7-4-I	M7	4 mm
FES153321	QSM-M7-6-I	M7	6 mm

MINI EQUAL ELBOW  
SOLD IN PACKS OF 10



3130

PART NUMBER	TYPE	TUBE OD
FES153346	QSML-3H	3 mm
FES153347	QSML-4H	4 mm
FES153348	QSML-6H	6 mm

BLANKING PLUG  
BSPP MALE  
SOLD IN PACKS OF 10



3130

PART NUMBER	TYPE	THREAD
FES3568	B-1/8	1/8" BSPP
FES3569	B-1/4	1/4" BSPP
FES3570	B-3/8	3/8" BSPP
FES3571	B-1/2	1/2" BSPP
FES3572	B-3/4	3/4" BSPP
FES5763	B-1	1" BSPP

MINI REDUCING ELBOW  
SOLD IN PACKS OF 10



3130

PART NUMBER	TYPE	TUBE OD	TUBE OD
FES153349	QSML-4H-3	4 mm	3 mm
FES153350	QSML-6H-4	6 mm	4 mm

BLANKING PLUG  
METRIC MALE  
SOLD IN PACKS OF 10



3130

PART NUMBER	TYPE	THREAD
FES30979	B-M3-S9	M3
FES3843	B-M5	M5
FES174308	B-M5-B	M5
FES174309	B-M7	M7

MINI PUSH IN TEE CONNECTOR  
SOLD IN PACKS OF 10



3130

PART NUMBER	TYPE	TUBE OD	TUBE OD
FES153368	QSMT-4-3	4 mm	3 mm
FES153369	QSMT-6-4	6 mm	4 mm



QSM SERIES QUICK STAR – MINI PUSH-IN FITTINGS

EQUAL ELBOW  
SOLD IN PACKS OF 10



3130

PART NUMBER	TYPE	TUBE OD
FES153343	QSML-3	3 mm
FES153344	QSML-4	4 mm
FES153345	QSML-6	6 mm

360° SWIVEL TEE  
BSPT MALE  
WITH EXTERNAL HEX  
SOLD IN PACKS OF 10



3130

PART NUMBER	TYPE	THREAD	TUBE OD
FES153355	QSMT-1/8-4	1/8" BSPT	4 mm
FES153357	QSMT-1/8-6	1/8" BSPT	6 mm

360° SWIVEL TEE  
METRIC MALE  
WITH EXTERNAL HEX  
SOLD IN PACKS OF 10



3130

PART NUMBER	TYPE	THREAD	TUBE OD
FES153351	QSMT-M3-3	M3	3 mm
FES153353	QSMT-M3-4	M3	4 mm
FES153354	QSMT-M5-4	M5	4 mm
FES153356	QSMT-M5-6	M5	6 mm

EQUAL TEE  
SOLD IN PACKS OF 10



3130

PART NUMBER	TYPE	TUBE OD
FES153365	QSMT-3	3 mm
FES153366	QSMT-4	4 mm
FES153367	QSMT-6	6 mm

EQUAL Y  
SOLD IN PACKS OF 10



3130

PART NUMBER	TYPE	TUBE OD
FES153370	QSMY-3	3 mm
FES153371	QSMY-4	4 mm
FES153372	QSMY-6	6 mm

BULKHEAD CONNECTOR  
SOLD IN PACKS OF 10



3130

PART NUMBER	TYPE	TUBE OD
FES153375	QSMS-3	3 mm
FES153376	QSMS-4	4 mm
FES153377	QSMS-6	6 mm

QSLV SERIES QUICK STAR – MULTIPLE DISTRIBUTORS



FEATURES

- Easy to insert tubing
- Easy to release
- Up to 6 outlets
- Rotatable 360°
- Types in accordance with ATEX directive for potentially explosive atmospheres

SPECIFICATIONS

Pressure range (bar)	-0.95 to +14
Temperature range	-10°C to +80°C

MATERIALS

Release ring	POM (colour: blue)
Seal	NBR
Body	PBT
Tube clamping segment	High alloy stainless steel
Threaded coupling	Nickel plated brass

360° SWIVEL DOUBLE ELBOW  
BSPT MALE WITH EXTERNAL HEX  
SOLD IN PACKS OF 10



3130

PART NUMBER	TYPE	THREAD	TUBE OD
FES153211	QSLV2-1/8-4	1/8" BSPT	4 mm
FES153212	QSLV2-1/8-6	1/8" BSPT	6 mm
FES153214	QSLV2-1/8-8	1/8" BSPT	8 mm
FES153213	QSLV2-1/4-6	1/4" BSPT	6 mm
FES153215	QSLV2-1/4-8	1/4" BSPT	8 mm
FES153217	QSLV2-1/4-10	1/4" BSPT	10 mm

NPQP ranges for food & beverage applications also available.  
Please contact your distributor for further information.



# Camozzi Fittings

Camozzi's standard range of fittings includes rapid, super rapid, and universal options, accessories, quick-release brass, technopolymer, and stainless-steel couplings.

Each component guarantees reliable sealing over time, minimising the risk of leakages. The range comprises various shapes and configurations, making mounting on any device or machine easy.

Series 5000 quick-release couplings are ideal when tubing needs to be repeatedly connected or disconnected for plant engineering or safety reasons. These couplings make it possible to perform these operations without releasing the pressure, saving valuable time.

## Applications

- Packaging
- Food and beverage
- Automotive
- Electronic system
- Assembly and robotics
- Printing and paper

## Available Ranges

- BSP Super Rapid Push-In Fittings for Plastic Tube
- Micro Super Rapid Fittings for Plastic Tube

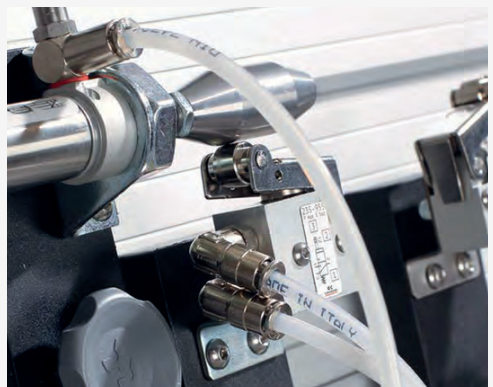
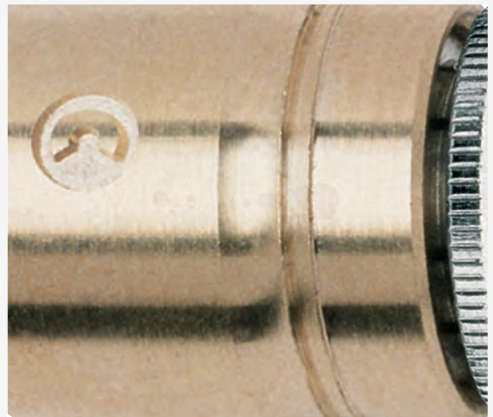
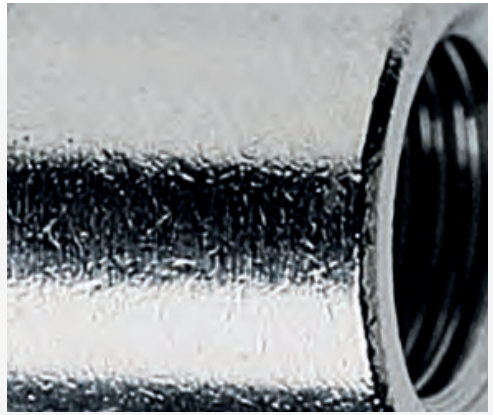

### SPECIFICATIONS

Operating pressure	0.8 to 16 bar (232 psi)
Operating temperature	-10°C to +60°C (14°F to 140°F)
Body & collet materials	Nickel plated brass
Threads	BSPP with PTFE sealing ring
Tube to connect	Nylon 6, 11, 12, polyurethane & polyethylene
Media	Compressed air

### STUD COUPLING WITH SEALING RING BSPP MALE



2520

PART NUMBER	TUBE OD	THREAD
ZS6510041/8	4 mm	1/8" BSPP
ZS6510041/4	4 mm	1/4" BSPP
ZS6510051/8	5 mm	1/8" BSPP
ZS6510051/4	5 mm	1/4" BSPP
ZS6510061/8	6 mm	1/8" BSPP
ZS6510061/4	6 mm	1/4" BSPP
ZS6510081/8	8 mm	1/8" BSPP
ZS6510081/4	8 mm	1/4" BSPP
ZS6510083/8	8 mm	3/8" BSPP
ZS6510101/4	10 mm	1/4" BSPP
ZS6510103/8	10 mm	3/8" BSPP
ZS6510101/2	10 mm	1/2" BSPP
ZS6510121/4	12 mm	1/4" BSPP
ZS6510123/8	12 mm	3/8" BSPP
ZS6510121/2	12 mm	1/2" BSPP
ZS6510143/8	14 mm	3/8" BSPP
ZS6510141/2	14 mm	1/2" BSPP

### STUD COUPLING WITH O-RING METRIC MALE



2520

PART NUMBER	TUBE OD	THREAD
Z651204M5	4 mm	M5
Z651204M6	4 mm	M6
Z651205M5	5 mm	M5
Z651206M5	6 mm	M5

### BSPP MALE

PART NUMBER	TUBE OD	THREAD
Z6512041/8	4 mm	1/8" BSPP
Z6512041/4	4 mm	1/4" BSPP
Z6512061/8	6 mm	1/8" BSPP
Z6512061/4	6 mm	1/4" BSPP
Z6512081/8	8 mm	1/8" BSPP
Z6512081/4	8 mm	1/4" BSPP
Z6512083/8	8 mm	3/8" BSPP
Z6512101/4	10 mm	1/4" BSPP
Z6512103/8	10 mm	3/8" BSPP
Z6512121/4	12 mm	1/4" BSPP
Z6512123/8	12 mm	3/8" BSPP

### STUD COUPLING METRIC FEMALE



2520

PART NUMBER	TUBE OD	THREAD
Z646304M5	4 mm	M5

### BSPP FEMALE

PART NUMBER	TUBE OD	THREAD
Z6463041/8	4 mm	1/8" BSPP
Z6463051/8	5 mm	1/8" BSPP
Z6463061/8	6 mm	1/8" BSPP
Z6463061/4	6 mm	1/4" BSPP
Z6463081/8	8 mm	1/8" BSPP
Z6463081/4	8 mm	1/4" BSPP
Z6463101/4	10 mm	1/4" BSPP

### EQUAL STRAIGHT CONNECTOR



2520

PART NUMBER	TUBE OD
Z658004	4 mm
Z658005	5 mm
Z658006	6 mm
Z658008	8 mm
Z658010	10 mm
Z658012	12 mm
Z658014	14 mm

### BULKHEAD CONNECTOR



2520

PART NUMBER	TUBE OD
Z659004	4 mm
Z659005	5 mm
Z659006	6 mm
Z659008	8 mm
Z659010	10 mm
Z659012	12 mm
Z659014	14 mm

### EQUAL ELBOW



2520

PART NUMBER	TUBE OD
Z655004	4 mm
Z655005	5 mm
Z655006	6 mm
Z655008	8 mm
Z655010	10 mm
Z655012	12 mm
Z655014	14 mm

**STUD SWIVEL ELBOW  
WITH SEALING RING  
BSPP MALE**

2520

PART NUMBER	TUBE OD	THREAD
ZS6520041/8	4 mm	1/8" BSPP
ZS6520041/4	4 mm	1/4" BSPP
ZS6520051/8	5 mm	1/8" BSPP
ZS6520051/4	5 mm	1/4" BSPP
ZS6520061/8	6 mm	1/8" BSPP
ZS6520061/4	6 mm	1/4" BSPP
ZS6520081/8	8 mm	1/8" BSPP
ZS6520081/4	8 mm	1/4" BSPP
ZS6520083/8	8 mm	3/8" BSPP
ZS6520101/4	10 mm	1/4" BSPP
ZS6520103/8	10 mm	3/8" BSPP
ZS6520101/2	10 mm	1/2" BSPP
ZS6520121/4	12 mm	1/4" BSPP
ZS6520123/8	12 mm	3/8" BSPP
ZS6520121/2	12 mm	1/2" BSPP
ZS6520143/8	14 mm	3/8" BSPP
ZS6520141/2	14 mm	1/2" BSPP

**STUD SWIVEL ELBOW  
WITH O-RING  
METRIC MALE**

2520

PART NUMBER	TUBE OD	THREAD
Z652204M5	4 mm	M5
Z652205M5	5 mm	M5
Z652206M5	6 mm	M5

**BSPP MALE**

PART NUMBER	TUBE OD	THREAD
Z6522041/8	4 mm	1/8" BSPP
Z6522041/4	4 mm	1/4" BSPP
Z6522061/8	6 mm	1/8" BSPP
Z6522061/4	6 mm	1/4" BSPP
Z6522081/8	8 mm	1/8" BSPP
Z6522081/4	8 mm	1/4" BSPP
Z6522083/8	8 mm	3/8" BSPP
Z6522101/4	10 mm	1/4" BSPP
Z6522103/8	10 mm	3/8" BSPP
Z6522121/4	12 mm	1/4" BSPP
Z6522123/8	12 mm	3/8" BSPP

**SWIVEL BRANCH TEE  
WITH SEALING RING  
BSPP MALE**

2520

PART NUMBER	TUBE OD	THREAD
ZS6430041/8	4 mm	1/8" BSPP
ZS6430051/8	5 mm	1/8" BSPP
ZS6430051/4	5 mm	1/4" BSPP
ZS6430061/8	6 mm	1/8" BSPP
ZS6430061/4	6 mm	1/4" BSPP
ZS6430081/8	8 mm	1/8" BSPP
ZS6430081/4	8 mm	1/4" BSPP
ZS6430083/8	8 mm	3/8" BSPP
ZS6430101/4	10 mm	1/4" BSPP
ZS6430103/8	10 mm	3/8" BSPP
ZS6430121/4	12 mm	1/4" BSPP
ZS6430123/8	12 mm	3/8" BSPP
ZS6430121/2	12 mm	1/2" BSPP
ZS6430141/2	14 mm	1/2" BSPP

**SWIVEL BRANCH TEE  
WITH O-RING  
METRIC MALE**

2520

PART NUMBER	TUBE OD	THREAD
Z643204M5	4 mm	M5
Z643205M5	5 mm	M5

**BSPP MALE**

PART NUMBER	TUBE OD	THREAD
Z6432041/8	4 mm	1/8" BSPP
Z6432061/8	6 mm	1/8" BSPP
Z6432061/4	6 mm	1/4" BSPP
Z6432081/8	8 mm	1/8" BSPP
Z6432081/4	8 mm	1/4" BSPP
Z6432083/8	8 mm	3/8" BSPP
Z6432101/4	10 mm	1/4" BSPP
Z6432103/8	10 mm	3/8" BSPP
Z6432121/4	12 mm	1/4" BSPP
Z6432123/8	12 mm	3/8" BSPP

**SWIVEL RUN TEE  
WITH SEALING RING  
BSPP MALE**

2520

PART NUMBER	TUBE OD	THREAD
ZS6440041/8	4 mm	1/8" BSPP
ZS6440051/8	5 mm	1/8" BSPP
ZS6440061/8	6 mm	1/8" BSPP
ZS6440061/4	6 mm	1/4" BSPP
ZS6440081/8	8 mm	1/8" BSPP
ZS6440081/4	8 mm	1/4" BSPP
ZS6440083/8	8 mm	3/8" BSPP
ZS6440101/4	10 mm	1/4" BSPP
ZS6440103/8	10 mm	3/8" BSPP
ZS6440123/8	12 mm	3/8" BSPP
ZS6440141/2	14 mm	1/2" BSPP

**SWIVEL RUN TEE  
WITH O-RING  
METRIC MALE**

2520

PART NUMBER	TUBE OD	THREAD
Z644204M5	4 mm	M5
Z644205M5	5 mm	M5

**BSPP MALE**

PART NUMBER	TUBE OD	THREAD
Z6442041/8	4 mm	1/8" BSPP
Z6442061/8	6 mm	1/8" BSPP
Z6442061/4	6 mm	1/4" BSPP
Z6442081/8	8 mm	1/8" BSPP
Z6442081/4	8 mm	1/4" BSPP
Z6442083/8	8 mm	3/8" BSPP
Z6442101/4	10 mm	1/4" BSPP
Z6442103/8	10 mm	3/8" BSPP
Z6442121/4	12 mm	1/4" BSPP
Z6442123/8	12 mm	3/8" BSPP



**EQUAL TEE**

2520

PART NUMBER	TUBE OD
Z654004	4 mm
Z654005	5 mm
Z654006	6 mm
Z654008	8 mm
Z654010	10 mm
Z654012	12 mm
Z654014	14 mm

**EQUAL CROSS**

2520

PART NUMBER	TUBE OD
Z66004	4 mm
Z66005	5 mm
Z66008	8 mm
Z66010	10 mm
Z66012	12 mm

**SWIVEL Y CONNECTOR**

2520

PART NUMBER	TUBE OD	THREAD
Z645104M5	4 mm	M5
Z645106M5	6 mm	M5

**SWIVEL Y CONNECTOR  
BSPP MALE**

2520

PART NUMBER	TUBE OD	THREAD
ZS6450041/8	4 mm	1/8" BSPP
ZS6450061/8	6 mm	1/8" BSPP
ZS6450081/8	8 mm	1/8" BSPP
ZS6450081/4	8 mm	1/4" BSPP

**EQUAL Y CONNECTOR**

2520

PART NUMBER	TUBE OD
Z65604	4 mm
Z65606	6 mm
Z65608	8 mm
Z656010	10 mm

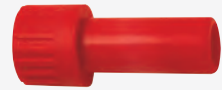
**PLASTIC BLANKING PLUG**

2520

PART NUMBER	TUBE OD
Z69004	4 mm
Z69005	5 mm
Z69006	6 mm
Z69008	8 mm
Z690010	10 mm
Z690012	12 mm
Z690014	14 mm

**TUBE BLANKING CAP**

2520

PART NUMBER	TUBE OD
Z67504	4 mm
Z67506	6 mm
Z67508	8 mm
Z675010	10 mm
Z675012	12 mm

**STEM ADAPTOR  
METRIC MALE**

2520

PART NUMBER	TUBE OD	THREAD
Z681104M5	4 mm	M5

**BSPP MALE**

Z6811041/8	4 mm	1/8" BSPP
Z6811051/8	5 mm	1/8" BSPP
Z6811051/4	5 mm	1/4" BSPP
Z6811061/8	6 mm	1/8" BSPP
Z6811061/4	6 mm	1/4" BSPP
Z6811081/8	8 mm	1/8" BSPP
Z6811081/4	8 mm	1/4" BSPP
Z6811101/4	10 mm	1/4" BSPP
Z6811103/8	10 mm	3/8" BSPP
Z6811123/8	12 mm	3/8" BSPP
Z6811141/2	14 mm	1/2" BSPP

**PRESS FIT CARTRIDGE**

2520

PART NUMBER	TUBE OD
Z67004	4 mm
Z67005	5 mm
Z67006	6 mm
Z67008	8 mm
Z670010	10 mm





**TUBE STEM INCREASER**

2520

PART NUMBER	TUBE OD	STEM OD
Z685064	6 mm	4 mm
Z685086	8 mm	6 mm



**STRAIGHT STEM**

2520

PART NUMBER	TUBE OD
Z695004	4 mm
Z695006	6 mm
Z695008	8 mm
Z695010	10 mm
Z695012	12 mm
Z695014	14 mm



**STEM REDUCER**

2520

PART NUMBER	TUBE OD	STEM OD
Z680004-05	4 mm	5 mm
Z680004-06	4 mm	6 mm
Z680004-08	4 mm	8 mm
Z680005-06	5 mm	6 mm
Z680005-08	5 mm	8 mm
Z680006-08	6 mm	8 mm
Z680006-10	6 mm	10 mm
Z680006-12	6 mm	12 mm
Z680008-10	8 mm	10 mm
Z680008-12	8 mm	12 mm
Z680010-12	10 mm	12 mm
Z680010-14	10 mm	14 mm
Z680012-14	12 mm	14 mm



**TUBE TO STEM ELBOW**

2520

PART NUMBER	TUBE OD	STEM OD
Z655504-04	4 mm	4 mm
Z655506-06	6 mm	6 mm
Z655508-08	8 mm	8 mm
Z65551010	10 mm	10 mm



**DUST COVER**

2520

PART NUMBER	TUBE OD
Z67084	4 mm
Z67085	5 mm
Z67086	6 mm
Z67088	8 mm
Z670810	10 mm
Z670812	12 mm
Z670814	14 mm



**SINGLE BANJO CONNECTOR FOR USE WITH BANJO BOLTS**

2520

PART NUMBER	TUBE OD	BOLT THREAD
Z661004M5	4 mm	M5
Z661004M6	4 mm	M6
Z6610041/8	4 mm	1/8"
Z661005M5	5 mm	M5
Z661005M6	5 mm	M6
Z661006M5	6 mm	M5
Z661006M6	6 mm	M6
Z6610061/8	6 mm	1/8"
Z6610061/4	6 mm	1/4"
Z6610081/8	8 mm	1/8"
Z6610081/4	8 mm	1/4"
Z6610101/4	10 mm	1/4"
Z6610103/8	10 mm	3/8"



**DOUBLE BANJO CONNECTOR FOR USE WITH BANJO BOLTS**

2520

PART NUMBER	TUBE OD	BOLT THREAD
Z662004M5	4 mm	M5
Z6620041/8	4 mm	1/8"
Z6620061/8	6 mm	1/8"
Z6620061/4	6 mm	1/4"
Z6620081/8	8 mm	1/8"
Z6620081/4	8 mm	1/4"



**SINGLE BANJO CONNECTOR WITH O-RING METRIC MALE**

2520

PART NUMBER	TUBE OD	THREAD
Z662204M5	4 mm	M5

**BSPP MALE**

Z6622041/8	4 mm	1/8" BSPP
Z6622061/8	6 mm	1/8" BSPP
Z6622061/4	6 mm	1/4" BSPP
Z6622081/8	8 mm	1/8" BSPP
Z6622081/4	8 mm	1/4" BSPP
Z6622101/4	10 mm	1/4" BSPP



**DOUBLE BANJO CONNECTOR WITH O-RING BSPP MALE**

2520

PART NUMBER	TUBE OD	THREAD
Z6632041/8	4 mm	1/8" BSPP
Z6632061/8	6 mm	1/8" BSPP
Z6632061/4	6 mm	1/4" BSPP
Z6632081/8	8 mm	1/8" BSPP
Z6632081/4	8 mm	1/4" BSPP
Z6632101/4	10 mm	1/4" BSPP

Do you also need?



**Banjo bolts**

Find it on page 584, section nine

### SPECIFICATIONS

Operating pressure	0.8 to 16 bar (232 psi)
Operating temperature	-10°C to +60°C (14°F to 140°F)
Body & collet materials	Nickel plated brass
Threads	BSPP with NBR O-ring
Tube to connect	Nylon 6, 11, 12, polyurethane & polyethylene
Media	Compressed air

### STUD COUPLING WITH O-RING METRIC MALE



2520

PART NUMBER	TUBE OD	THREAD
Z651203M3	3 mm	M3
Z651203M5	3 mm	M5
Z651206M7	6 mm	M7

### BSPP MALE

Z65120418M	4 mm	1/8" BSPP
Z65120618M	6 mm	1/8" BSPP
Z65120818M	8 mm	1/8" BSPP

### SINGLE BANJO CONNECTOR METRIC MALE



2520

PART NUMBER	TUBE OD	THREAD
Z662103M3	3 mm	M3
Z662103M5	3 mm	M5

### SWIVEL RUN TEE WITH O-RING METRIC MALE



2520

PART NUMBER	TUBE OD	THREAD
Z644203M3	3 mm	M3
Z644203M5	3 mm	M5

### EQUAL STRAIGHT CONNECTOR



2520

PART NUMBER	TUBE OD
Z658003	3 mm

### EQUAL ELBOW



2520

PART NUMBER	TUBE OD
Z655003	3 mm

### Y CONNECTOR



2520

PART NUMBER	TUBE OD
Z65603	3 mm

### PRESS FIT CARTRIDGE



2520

PART NUMBER	TUBE OD
Z67003	3 mm

### STUD SWIVEL ELBOW WITH O-RING METRIC MALE



2520

PART NUMBER	TUBE OD	THREAD
Z652203M3	3 mm	M3
Z652203M5	3 mm	M5

### SWIVEL BRANCH TEE WITH O-RING METRIC MALE



2520

PART NUMBER	TUBE OD	THREAD
Z643203M3	3 mm	M3
Z643203M5	3 mm	M5

### SWIVEL Y CONNECTOR METRIC MALE

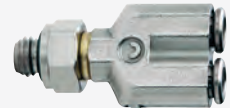

2520

PART NUMBER	TUBE OD	THREAD
Z645203M3	3 mm	M3
Z645203M5	3 mm	M5

### BULKHEAD CONNECTOR



2520

PART NUMBER	TUBE OD
Z659003	3 mm

### EQUAL TEE



2520

PART NUMBER	TUBE OD
Z654003	3 mm

### STEM ADAPTOR



2520

PART NUMBER	TUBE OD	STEM OD
Z680003-04	3 mm	4 mm

### NYLON BLANKING PLUG



2520

PART NUMBER	TUBE
Z69003	3 mm





STRAIGHT ADAPTOR  
BSPT MALE



3720

PART NUMBER	TUBE OD	THREAD
CDHPC0401	4 mm	1/8" BSPT
CDHPC0601	6 mm	1/8" BSPT
CDHPC0602	6 mm	1/4" BSPT
CDHPC0603	6 mm	3/8" BSPT
CDHPC0604	6 mm	1/2" BSPT
CDHPC0801	8 mm	1/8" BSPT
CDHPC0802	8 mm	1/4" BSPT
CDHPC0803	8 mm	3/8" BSPT
CDHPC1002	10 mm	1/4" BSPT
CDHPC1003	10 mm	3/8" BSPT
CDHPC1004	10 mm	1/2" BSPT
CDHPC1203	12 mm	3/8" BSPT
CDHPC1204	12 mm	1/2" BSPT



TAP CONNECTOR  
BSPP FEMALE



3720

PART NUMBER	TUBE OD	THREAD
CDHCF06-NH06	6 mm	3/4" BSPP
CDHCF08-NH06	8 mm	3/4" BSPP
CDHCF10-NH06	10 mm	3/4" BSPP



STRAIGHT ADAPTOR  
BSPP MALE



3720

PART NUMBER	TUBE OD	THREAD
CDHPC04G01	4 mm	1/8" BSPP
CDHPC04G02	4 mm	1/4" BSPP
CDHPC06G01	6 mm	1/8" BSPP
CDHPC06G02	6 mm	1/4" BSPP
CDHPC08G01	8 mm	1/8" BSPP
CDHPC08G02	8 mm	1/4" BSPP
CDHPC08G03	8 mm	3/8" BSPP
CDHPC08G04	8 mm	1/2" BSPP
CDHPC10G02	10 mm	1/4" BSPP
CDHPC10G03	10 mm	3/8" BSPP
CDHPC10G04	10 mm	1/2" BSPP
CDHPC12G03	12 mm	3/8" BSPP
CDHPC12G04	12 mm	1/2" BSPP
CDHPC15G04	15 mm	1/2" BSPP
CDHPC15G06	15 mm	3/4" BSPP
CDHPC22G06	22 mm	3/4" BSPP

STEM ADAPTOR  
BSPT MALE



3720

PART NUMBER	STEM OD	THREAD
CDHCJ0401	4 mm	1/8" BSPT
CDHCJ0402	4 mm	1/4" BSPT
CDHCJ0601	6 mm	1/8" BSPT
CDHCJ0602	6 mm	1/4" BSPT
CDHCJ0801	8 mm	1/8" BSPT
CDHCJ0802	8 mm	1/4" BSPT
CDHCJ0803	8 mm	3/8" BSPT
CDHCJ1002	10 mm	1/4" BSPT
CDHCJ1003	10 mm	3/8" BSPT
CDHCJ1004	10 mm	1/2" BSPT
CDHCJ1203	12 mm	3/8" BSPT
CDHCJ1204	12 mm	1/2" BSPT



STRAIGHT  
BSPP FEMALE



3720

PART NUMBER	TUBE OD	THREAD
CDHCF04G01	4 mm	1/8" BSPP
CDHCF06G01	6 mm	1/8" BSPP
CDHCF06G02	6 mm	1/4" BSPP
CDHCF06G03	6 mm	3/8" BSPP
CDHCF06G06	6 mm	3/4" BSPP
CDHCF08G01	8 mm	1/8" BSPP
CDHCF08G02	8 mm	1/4" BSPP
CDHCF08G03	8 mm	3/8" BSPP
CDHCF08G04	8 mm	1/2" BSPP
CDHCF08G06**	8 mm	3/4" BSPP
CDHCF10G02	10 mm	1/4" BSPP
CDHCF10G03	10 mm	3/8" BSPP
CDHCF10G04	10 mm	1/2" BSPP
CDHCF10G06**	10 mm	3/4" BSPP
CDHCF12G02	12 mm	1/4" BSPP
CDHCF12G03	12 mm	3/8" BSPP
CDHCF12G04	12 mm	1/2" BSPP
CDHCF15G04*	15 mm	1/2" BSPP
CDHCF15G06*	15 mm	3/4" BSPP

STEM ADAPTOR  
BSPP MALE



3720

PART NUMBER	STEM OD	THREAD
CDHCJ04G01	4 mm	1/8" BSPP
CDHCJ04G02	4 mm	1/4" BSPP
CDHCJ06G01	6 mm	1/8" BSPP
CDHCJ06G02	6 mm	1/4" BSPP
CDHCJ08G01	8 mm	1/8" BSPP
CDHCJ08G02	8 mm	1/4" BSPP
CDHCJ08G03	8 mm	3/8" BSPP
CDHCJ10G02	10 mm	1/4" BSPP
CDHCJ10G03	10 mm	3/8" BSPP
CDHCJ10G04	10 mm	1/2" BSPP
CDHCJ12G03	12 mm	3/8" BSPP
CDHCJ12G04	12 mm	1/2" BSPP
CDHCJ15G03	15 mm	3/8" BSPP
CDHCJ15G04	15 mm	1/2" BSPP
CDHCJ22G04	22 mm	1/2" BSPP
CDHCJ22G06	22 mm	3/4" BSPP

\*15 mm are not WRAS approved products  
\*\* CDHCF08G06 & CDHCF10G06 fittings have a brass thread



**BULKHEAD**

PART NUMBER	TUBE OD
CDHMM0404	4 mm
CDHMM0606	6 mm
CDHMM0808	8 mm
CDHMM1010	10 mm
CDHMM1212	12 mm

**REDUCING BULKHEAD**

PART NUMBER	TUBE OD	TUBE OD
CDHMM0604	6 mm	4 mm
CDHMM0806	8 mm	6 mm



**STEM ELBOW**

PART NUMBER	STEM OD A	TUBE OD B
CDHLJ0404	4 mm	4 mm
CDHLJ0606	6 mm	6 mm
CDHLJ0808	8 mm	8 mm
CDHLJ1010	10 mm	10 mm
CDHLJ1212	12 mm	12 mm
CDHLJ1515	15 mm	15 mm
CDHLJ2222	22 mm	22 mm

**REDUCING STEM ELBOW**

CDHLJ0608	6 mm	8 mm
CDHLJ1006	10 mm	6 mm
CDHLJ1008	10 mm	8 mm



**EQUAL UNION STRAIGHT**

PART NUMBER	TUBE OD
CDHUC0404	4 mm
CDHUC0606	6 mm
CDHUC0808	8 mm
CDHUC1010	10 mm
CDHUC1212	12 mm
CDHUC1515*	15 mm
CDHUC2222*	22 mm

**REDUCING UNION STRAIGHT**

PART NUMBER	TUBE OD	TUBE OD
CDHUC0604	6 mm	4 mm
CDHUC0605	6 mm	5 mm
CDHUC0804	8 mm	4 mm
CDHUC0806	8 mm	6 mm
CDHUC1006	10 mm	6 mm
CDHUC1008	10 mm	8 mm
CDHUC1208	12 mm	8 mm
CDHUC1210	12 mm	10 mm

\*15 mm & 22 mm are not WRAS approved products



**RIGID ELBOW  
BSPT MALE**

PART NUMBER	TUBE OD	THREAD
CDHPL0401	4 mm	1/8" BSPT
CDHPL0402	4 mm	1/4" BSPT
CDHPL0601	6 mm	1/8" BSPT
CDHPL0602	6 mm	1/4" BSPT
CDHPL0603	6 mm	3/8" BSPT
CDHPL0802	8 mm	1/4" BSPT
CDHPL0803	8 mm	3/8" BSPT
CDHPL1002	10 mm	1/4" BSPT
CDHPL1003	10 mm	3/8" BSPT
CDHPL1202	12 mm	1/4" BSPT
CDHPL1203	12 mm	3/8" BSPT
CDHPL1204	12 mm	1/2" BSPT



**STEM REDUCER**

PART NUMBER	STEM OD A	TUBE OD B
CDHGJ0604	6 mm	4 mm
CDHGJ0804	8 mm	4 mm
CDHGJ0806	8 mm	6 mm
CDHGJ0810	8 mm	10 mm
CDHGJ1006	10 mm	6 mm
CDHGJ1008	10 mm	8 mm
CDHGJ1208	12 mm	8 mm
CDHGJ1210	12 mm	10 mm
CDHGJ1510*	15 mm	10 mm
CDHGJ1512*	15 mm	12 mm
CDHGJ2215*	22 mm	15 mm

\*15 mm & 22 mm are not WRAS approved products



**EQUAL ELBOW**

PART NUMBER	TUBE OD
CDHUL0404	4 mm
CDHUL0606	6 mm
CDHUL0808	8 mm
CDHUL1010	10 mm
CDHUL1212	12 mm
CDHUL1515*	15 mm
CDHUL2222*	22 mm

**REDUCING ELBOW**

PART NUMBER	TUBE OD	TUBE OD
CDHUL0804	8 mm	4 mm
CDHUL0806	8 mm	6 mm
CDHUL1006	10 mm	6 mm
CDHUL1008	10 mm	8 mm
CDHUL1206	12 mm	6 mm
CDHUL1208	12 mm	8 mm
CDHUL1210	12 mm	10 mm

\*15 mm & 22 mm are not WRAS approved products





PART NUMBER	TUBE OD
CDHUT0404	4 mm
CDHUT0606	6 mm
CDHUT0808	8 mm
CDHUT1010	10 mm
CDHUT1212	12 mm
CDHUT1515*	15 mm
CDHUT2222*	22 mm



PART NUMBER	TUBE OD
CDHPP04	4 mm
CDHPP06	6 mm
CDHPP08	8 mm
CDHPP10	10 mm
CDHPP12	12 mm
CDHPP15	15 mm
CDHPP22	22 mm

REDUCING TEE

PART NUMBER	TUBE OD	TUBE OD	TUBE OD
CDHUT100608	10 mm	6 mm	8 mm
CDHUT100610	10 mm	6 mm	10 mm
CDHUT121012	12 mm	10 mm	12 mm
CDHUT221222*	22 mm	12 mm	22 mm
CDHUT221522*	22 mm	15 mm	22 mm

\*15 mm & 22 mm are not WRAS approved products



PART NUMBER	TUBE OD
CDHCP04	4 mm
CDHCP05	5 mm
CDHCP06	6 mm
CDHCP08	8 mm
CDHCP10	10 mm
CDHCP12	12 mm
CDHCP15	15 mm
CDHCP22	22 mm



PART NUMBER	TUBE OD A	TUBE OD B
CDHUY0404	4 mm	4 mm
CDHUY0606	6 mm	6 mm
CDHUY0808	8 mm	8 mm
CDHUY1008	10 mm	8 mm
CDHUY1010	10 mm	10 mm
CDHUY1212	12 mm	12 mm



PART NUMBER	STEM OD A	HOSE ID B
CDHCJB0604	6 mm	4 mm
CDHCJB0606	6 mm	6 mm
CDHCJB0806	8 mm	6 mm
CDHCJB1006	10 mm	6 mm
CDHCJB1008	10 mm	8 mm
CDHCJB1010	10 mm	10 mm
CDHCJB1210	12 mm	10 mm



PART NUMBER	TUBE OD
CDHZA0606	6 mm
CDHZA0808	8 mm



PART NUMBER	TUBE OD
CDHPPF04	4 mm
CDHPPF06	6 mm
CDHPPF08	8 mm
CDHPPF10	10 mm
CDHPPF12	12 mm
CDHPPF15*	15 mm
CDHPPF22*	22 mm

\*15 mm & 22 mm are not WRAS approved products



PART NUMBER	STEM OD A	HOSE ID B
CDHLJB1006	10 mm	6 mm
CDHLJB1008	10 mm	8 mm





PART NUMBER	TUBE OD	THREAD
CDHRPL0401	4 mm	1/8" BSPT
CDHRPL0402	4 mm	1/4" BSPT
CDHRPL0601	6 mm	1/8" BSPT
CDHRPL0602	6 mm	1/4" BSPT
CDHRPL0801	8 mm	1/8" BSPT
CDHRPL0802	8 mm	1/4" BSPT
CDHRPL0803	8 mm	3/8" BSPT
CDHRPL1002	10 mm	1/4" BSPT
CDHRPL1003	10 mm	3/8" BSPT
CDHRPL1004	10 mm	1/2" BSPT
CDHRPL1203	12 mm	3/8" BSPT
CDHRPL1204	12 mm	1/2" BSPT



PART NUMBER	TUBE OD	THREAD
CDHRPT04G01	4 mm	1/8" BSPP
CDHRPT04G02	4 mm	1/4" BSPP
CDHRPT06G01	6 mm	1/8" BSPP
CDHRPT06G02	6 mm	1/4" BSPP
CDHRPT08G01	8 mm	1/8" BSPP
CDHRPT08G02	8 mm	1/4" BSPP
CDHRPT08G03	8 mm	3/8" BSPP
CDHRPT10G02	10 mm	1/4" BSPP
CDHRPT10G03	10 mm	3/8" BSPP
CDHRPT10G04	10 mm	1/2" BSPP
CDHRPT12G03	12 mm	3/8" BSPP
CDHRPT12G04	12 mm	1/2" BSPP



PART NUMBER	TUBE OD	THREAD
CDHRPL04G01	4 mm	1/8" BSPP
CDHRPL04G02	4 mm	1/4" BSPP
CDHRPL06G01	6 mm	1/8" BSPP
CDHRPL06G02	6 mm	1/4" BSPP
CDHRPL08G01	8 mm	1/8" BSPP
CDHRPL08G02	8 mm	1/4" BSPP
CDHRPL08G03	8 mm	3/8" BSPP
CDHRPL10G02	10 mm	1/4" BSPP
CDHRPL10G03	10 mm	3/8" BSPP
CDHRPL10G04	10 mm	1/2" BSPP
CDHRPL12G03	12 mm	3/8" BSPP
CDHRPL12G04	12 mm	1/2" BSPP



PART NUMBER	TUBE	THREAD
CDHRST0401	4 mm	1/8" BSPT
CDHRST0402	4 mm	1/4" BSPT
CDHRST0601	6 mm	1/8" BSPT
CDHRST0602	6 mm	1/4" BSPT
CDHRST0801	8 mm	1/8" BSPT
CDHRST0802	8 mm	1/4" BSPT
CDHRST0803	8 mm	3/8" BSPT
CDHRST1002	10 mm	1/4" BSPT
CDHRST1003	10 mm	3/8" BSPT
CDHRST1004	10 mm	1/2" BSPT
CDHRST1203	12 mm	3/8" BSPT
CDHRST1204	12 mm	1/2" BSPT



PART NUMBER	TUBE	THREAD
CDHRPT0401	4 mm	1/8" BSPT
CDHRPT0402	4 mm	1/4" BSPT
CDHRPT0601	6 mm	1/8" BSPT
CDHRPT0602	6 mm	1/4" BSPT
CDHRPT0801	8 mm	1/8" BSPT
CDHRPT0802	8 mm	1/4" BSPT
CDHRPT0803	8 mm	3/8" BSPT
CDHRPT1002	10 mm	1/4" BSPT
CDHRPT1003	10 mm	3/8" BSPT
CDHRPT1004	10 mm	1/2" BSPT
CDHRPT1203	12 mm	3/8" BSPT
CDHRPT1204	12 mm	1/2" BSPT



PART NUMBER	TUBE	THREAD
CDHRST04G01	4 mm	1/8" BSPP
CDHRST04G02	4 mm	1/4" BSPP
CDHRST06G01	6 mm	1/8" BSPP
CDHRST06G02	6 mm	1/4" BSPP
CDHRST08G01	8 mm	1/8" BSPP
CDHRST08G02	8 mm	1/4" BSPP
CDHRST08G03	8 mm	3/8" BSPP
CDHRST10G02	10 mm	1/4" BSPP
CDHRST10G03	10 mm	3/8" BSPP
CDHRST10G04	10 mm	1/2" BSPP
CDHRST12G03	12 mm	3/8" BSPP



PART NUMBER	TUBE OD A	HOSE ID B
CDHCVB15-1/2	15 mm	1/2"
CDHCVB22-1/2	22 mm	1/2"
CDHCVB22-3/4	22 mm	3/4"



PART NUMBER	TUBE OD A	HOSE ID B
CDHCBB1210	12 mm	3/8"
CDHCBB15-1/2	15 mm	1/2"
CDHCBB22-1/2	22 mm	1/2"
CDHCBB22-3/4	22 mm	3/4"



SWIVEL Y  
BSPT MALE



PART NUMBER	TUBE OD	THREAD
CDHRWT0401	4 mm	1/8" BSPT
CDHRWT0402	4 mm	1/4" BSPT
CDHRWT0601	6 mm	1/8" BSPT
CDHRWT0602	6 mm	1/4" BSPT
CDHRWT0801	8 mm	1/8" BSPT
CDHRWT0802	8 mm	1/4" BSPT
CDHRWT0803	8 mm	3/8" BSPT
CDHRWT1002	10 mm	1/4" BSPT
CDHRWT1003	10 mm	3/8" BSPT
CDHRWT1004	10 mm	1/2" BSPT
CDHRWT1203	12 mm	1/4" BSPT
CDHRWT1204	12 mm	1/2" BSPT



SWIVEL Y  
BSPP MALE



PART NUMBER	TUBE OD	THREAD
CDHRWT04G01	4 mm	1/8" BSPP
CDHRWT04G02	4 mm	1/4" BSPP
CDHRWT06G01	6 mm	1/8" BSPP
CDHRWT06G02	6 mm	1/4" BSPP
CDHRWT08G01	8 mm	1/8" BSPP
CDHRWT08G02	8 mm	1/4" BSPP
CDHRWT08G03	8 mm	3/8" BSPP
CDHRWT10G02	10 mm	1/4" BSPP
CDHRWT10G03	10 mm	3/8" BSPP
CDHRWT10G04	10 mm	1/2" BSPP
CDHRWT12G03	12 mm	3/8" BSPP
CDHRWT12G04	12 mm	1/2" BSPP

BRASS FITTINGS

BRASS TUBE INSERT  
F TYPE CARTRIDGE



PART NUMBER	TUBE OD
CDHCAS-F04	4 mm
CDHCAS-F06	6 mm
CDHCAS-F08	8 mm
CDHCAS-F10	10 mm
CDHCAS-F12	12 mm

BRASS TUBE INSERT  
H TYPE CARTRIDGE



PART NUMBER	TUBE OD
CDHCAS-H04	4 mm
CDHCAS-H06	6 mm
CDHCAS-H08	8 mm
CDHCAS-H10	10 mm
CDHCAS-H12	12 mm

Please contact your distributor for drilling dimensions

METRIC FLOW REGULATORS



ELBOW



PART NUMBER	TUBE OD
CDHSLB0606	6 mm
CDHSLB1010	10 mm



IN-LINE



PART NUMBER	TUBE OD
CDHSTB0606	6 mm
CDHSTB1010	10 mm

METRIC CHECK VALVES

NON-RETURN CHECK VALVE



PART NUMBER	TUBE OD
CDHCVU0404	4 mm
CDHCVU0606	6 mm
CDHCVU0808	8 mm
CDHCVU1010	10 mm
CDHCVU1212	12 mm

METRIC HAND BALL VALVES

HAND BALL VALVE



PART NUMBER	TUBE OD
CDHBVU0606	6 mm
CDHBVU0808	8 mm
CDHBVU1010	10 mm
CDHBVU1212	12 mm



**STRAIGHT ADAPTOR  
BSPP MALE**



PART NUMBER	TUBE OD	THREAD
CDHPC3/16-G01	3/16"	1/8" BSPP
CDHPC1/4-G01	1/4"	1/8" BSPP
CDHPC1/4-G02	1/4"	1/4" BSPP
CDHPC5/16-G01	5/16"	1/8" BSPP
CDHPC5/16-G02	5/16"	1/4" BSPP
CDHPC5/16-G03	5/16"	3/8" BSPP
CDHPC3/8-G02	3/8"	1/4" BSPP
CDHPC3/8-G03	3/8"	3/8" BSPP
CDHPC1/2-G03	1/2"	3/8" BSPP
CDHPC1/2-G04	1/2"	1/2" BSPP



**EQUAL ELBOW**



PART NUMBER	TUBE OD
CDHUL5/32	5/32"
CDHUL3/16	3/16"
CDHUL1/4	1/4"
CDHUL5/16	5/16"
CDHUL3/8	3/8"
CDHUL1/2	1/2"

**REDUCING ELBOW**

PART NUMBER	TUBE OD	TUBE OD
CDHUL5/16-5/32	5/16"	5/32"
CDHUL5/16-1/4	5/16"	1/4"
CDHUL3/8-1/4	3/8"	1/4"
CDHUL3/8-5/16	3/8"	5/16"
CDHUL1/2-5/16	1/2"	5/16"
CDHUL1/2-3/8	1/2"	3/8"



**EQUAL UNION STRAIGHT**



PART NUMBER	TUBE OD
CDHUC5/32	5/32"
CDHUC3/16	3/16"
CDHUC1/4	1/4"
CDHUC5/16	5/16"
CDHUC3/8	3/8"
CDHUC1/2	1/2"

**REDUCING UNION STRAIGHT**

PART NUMBER	TUBE OD	TUBE OD
CDHUC1/4-06	1/4"	6 mm
CDHUC5/16-5/32	5/16"	5/32"
CDHUC5/16-1/4	5/16"	1/4"
CDHUC3/8-3/16	3/8"	3/16"
CDHUC3/8-1/4	3/8"	1/4"
CDHUC3/8-5/16	3/8"	5/16"
CDHUC1/2-5/16	1/2"	5/16"
CDHUC1/2-3/8	1/2"	3/8"



**EQUAL TEE**



PART NUMBER	TUBE OD
CDHUT5/32	5/32"
CDHUT3/16	3/16"
CDHUT1/4	1/4"
CDHUT5/16	5/16"
CDHUT3/8	3/8"
CDHUT1/2	1/2"



**EQUAL UNION Y**



PART NUMBER	TUBE OD
CDHUY5/32	5/32"
CDHUY3/16	3/16"
CDHUY1/4	1/4"
CDHUY5/16	5/16"
CDHUY3/8	3/8"
CDHUY1/2	1/2"



**STRAIGHT ADAPTOR  
BSPP FEMALE**



PART NUMBER	TUBE OD	THREAD
CDHCF1/4-G04	1/4"	1/2" BSPP
CDHCF1/4-G06	1/4"	3/4" BSPP
CDHCF3/8-G03	3/8"	3/8" BSPP
CDHCF3/8-G04	3/8"	1/2" BSPP
CDHCF3/8-G05	3/8"	5/8" BSPP
CDHCF3/8-G06	3/8"	3/4" BSPP
CDHCF1/2-G04	1/2"	1/2" BSPP



**U BEND**



PART NUMBER	TUBE OD
CDHBU3/8-3/8	3/8"
CDHBU1/2-1/2	1/2"



**BULKHEAD**

PART NUMBER	TUBE OD
CDHMM5/32	5/32"
CDHMM1/4	1/4"
CDHMM5/16	5/16"
CDHMM3/8	3/8"
CDHMM1/2	1/2"

**REDUCING BULKHEAD**

PART NUMBER	TUBE OD	TUBE OD
CDHMM1/4-3/8	1/4"	3/8"



**STEM ELBOW**

PART NUMBER	STEM OD A	TUBE OD B
CDHLJ5/32	5/32"	5/32"
CDHLJ3/16	3/16"	3/16"
CDHLJ1/4	1/4"	1/4"
CDHLJ5/16	5/16"	5/16"
CDHLJ3/8	3/8"	3/8"
CDHLJ1/2	1/2"	1/2"

**REDUCING STEM ELBOW**

CDHLJ3/8-1/4	3/8"	1/4"
CDHLJ3/8-5/16	3/8"	5/16"



**STEM REDUCER**

PART NUMBER	STEM OD A	TUBE OD B
CDHGJ1/4-5/32	1/4"	5/32"
CDHGJ5/16-1/4	5/16"	1/4"
CDHGJ5/16-3/8	5/16"	3/8"
CDHGJ3/8-3/16	3/8"	3/16"
CDHGJ3/8-1/4	3/8"	1/4"
CDHGJ3/8-5/16	3/8"	5/16"
CDHGJ3/8-1/2	3/8"	1/2"
CDHGJ1/2-3/8	1/2"	3/8"
CDHGJ1/2-15	1/2"	15 mm



**STEM ELBOW**

PART NUMBER	STEM OD A	HOSE ID B
CDHLJB3/8-5/16	3/8"	5/16"
CDHLJB3/8-3/8	3/8"	3/8"



**STEM STRAIGHT**



PART NUMBER	STEM OD A	HOSE ID B
CDHCJB1/4-3/16	1/4"	3/16"
CDHCJB1/4-1/4	1/4"	1/4"
CDHCJB5/16-5/16	5/16"	5/16"
CDHCJB5/16-3/8	5/16"	3/8"
CDHCJB3/8-1/4	3/8"	1/4"
CDHCJB3/8-3/8	3/8"	3/8"
CDHCJB3/8-5/16	3/8"	5/16"
CDHCJB1/2-3/8	1/2"	3/8"
CDHCJB1/2-1/2	1/2"	1/2"



**END CAP**

PART NUMBER	TUBE OD
CDHPF5/32	5/32"
CDHPF1/4	1/4"
CDHPF5/16	5/16"
CDHPF3/8	3/8"
CDHPF1/2	1/2"



**PLUG**



PART NUMBER	TUBE OD
CDHPP5/32	5/32"
CDHPP3/16	3/16"
CDHPP1/4	1/4"
CDHPP5/16	5/16"
CDHPP3/8	3/8"
CDHPP1/2	1/2"



**CLIP**



PART NUMBER	TUBE OD
CDHCP5/32	5/32"
CDHCP3/16	3/16"
CDHCP1/4	1/4"
CDHCP5/16	5/16"
CDHCP3/8	3/8"
CDHCP1/2	1/2"

IMPERIAL FLOW REGULATORS



ELBOW  
FLOW REGULATOR



3720

PART NUMBER	TUBE OD
CDHSLB1/4-1/4	1/4"
CDHSLB3/8-3/8	3/8"



IN-LINE  
FLOW REGULATOR



3720

PART NUMBER	TUBE OD
CDHSTB1/4-1/4	1/4"
CDHSTB3/8-3/8	3/8"

IMPERIAL CHECK VALVES

SPECIFICATIONS

Max. working pressure	10 bar @ 65°C continuous use
Working temperature	90°C for short term 5 minutes max.
Cracking pressure	0.02 bar



NON-RETURN  
CHECK VALVE



3720

PART NUMBER	TUBE OD
CDHCVU5/32	5/32"
CDHCVU1/4	1/4"
CDHCVU5/16	5/16"
CDHCVU3/8	3/8"
CDHCVU1/2	1/2"

IMPERIAL HAND BALL VALVES

HAND BALL VALVE  
IMPERIAL  
SOLD IN PACKS OF 10



3720

PART NUMBER	TUBE OD
CDHBVU1/4-1/4	1/4"
CDHBVU5/16-5/16	5/16"
CDHBVU3/8-3/8	3/8"
CDHBVU1/2-1/2	1/2"

IMPERIAL THREAD TO THREAD



REDUCER  
BSPP FEMALE



3720

PART NUMBER	THREAD A	THREAD B
CDHUFF-G02-G06	1/4" BSPP	3/4" BSPP
CDHUFF-G03-G06	3/8" BSPP	3/4" BSPP

Do you also need?



Polyethylene tube

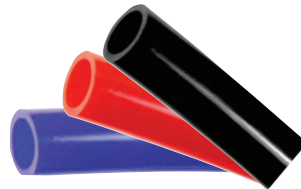

Find it on page 668, section ten



# John Guest Fittings

If you're looking for a reliable way to manage airflow, John Guest's push-fit fittings are an excellent option. These fittings are suitable for both small workshops and large industrial settings, and they can power various pneumatic tools, instruments, and ring main systems. With John Guest's push-fit fittings, you can assemble your compressed air and pneumatics systems quickly and easily without needing any tools.

The push-fit fittings from John Guest are made of rigid plastic and brass, providing excellent corrosion and pressure resistance. These fittings come in various sizes, making them suitable for various applications, including air, pneumatics, inert gases, vacuum, and potable liquids. Designed for easy and quick installation, the compressed air and pneumatic push-fit fittings from John Guest offer optimal airflow and pressure resistance, ensuring reliable performance.

They are designed for easy installation, require no tools, and provide airtight connections. They can be used for air piping systems up to 10 bar and are suitable for vacuum, inert gases, and potable liquid applications.

## Benefits

- Install air systems 50% faster with push-fit technology - no tools, threading, or solvents needed.
- Corrosion-resistant materials extend the lifecycle and efficiency of systems and equipment.
- Systems can be reconfigured quickly with minimal downtime thanks to demountable and interchangeable fittings that simplify layout changes.
- Moisture is eliminated from the airline to prevent equipment contamination, enhancing performance and longevity.
- Uninterrupted optimal airflow and quality – Airtight seal reduces energy consumption and eliminates pressure drops and leaks.
- Versatile solution for various pipes, including nylon, powder-coated aluminium, LLDPE, and soft metal.





## METRIC FITTINGS

As well as standard push-fit connections & metric fittings that work with specific threads, we offer selected fittings with SuperThread technology that enables them to be used with any thread type.

The special polyurethane seal feature means no sealant need be applied to make an airtight joint. There is no danger of tape entering the system.

Fittings with SuperThread also have countersunk throughbores to provide superior flow characteristics.

The design allows for a smaller compact body & reduced hexagon size.

### STRAIGHT ADAPTOR METRIC MALE



2110

PART NUMBER	TUBE OD	THREAD
JGRM0104M5	4 mm	M5
JGRM0105M5	5 mm	M5
JGRM0106M5	6 mm	M5

### STRAIGHT ADAPTOR WITH INTEGRAL SEAL UNIVERSAL MALE



2110

PART NUMBER	TUBE OD	THREAD
JGRM010411	4 mm	1/8"
JGRM010412	4 mm	1/4"
JGRM010512	5 mm	1/4"
JGRM010611	6 mm	1/8"
JGRM010612	6 mm	1/4"
JGRM010811	8 mm	1/8"
JGRM010812	8 mm	1/4"
JGRM010813	8 mm	3/8"
JGRM011012	10 mm	1/4"
JGRM011013	10 mm	3/8"
JGRM011014	10 mm	1/2"
JGRM011213	12 mm	3/8"
JGRM011214	12 mm	1/2"

Thread can be used with BSPP, BSPT, NPT, PF & PT



### STRAIGHT ADAPTOR BSPP MALE



2110

PART NUMBER	TUBE OD	THREAD
JGPM010411E	4 mm	1/8" BSPP
JGPM010412E	4 mm	1/4" BSPP
JGPM010511E	5 mm	1/8" BSPP
JGPM010512E	5 mm	1/4" BSPP
JGPM010611E	6 mm	1/8" BSPP
JGPM010612E	6 mm	1/4" BSPP
JGPM010811E	8 mm	1/8" BSPP
JGPM010812E	8 mm	1/4" BSPP
JGPM010813E	8 mm	3/8" BSPP
JGPM011012E	10 mm	1/4" BSPP
JGPM011013E	10 mm	3/8" BSPP
JGPM011014E	10 mm	1/2" BSPP
JGPM011213E	12 mm	3/8" BSPP
JGPM011214E	12 mm	1/2" BSPP



### STRAIGHT ADAPTOR BSPT MALE



2110

PART NUMBER	TUBE OD	THREAD
JGPM010401E	4 mm	1/8" BSPT
JGPM010402E	4 mm	1/4" BSPT
JGPM010501E	5 mm	1/8" BSPT
JGPM010601E	6 mm	1/8" BSPT
JGPM010602E	6 mm	1/4" BSPT
JGPM010801E	8 mm	1/8" BSPT
JGPM010802E	8 mm	1/4" BSPT
JGPM010803E	8 mm	3/8" BSPT
JGPM011002E	10 mm	1/4" BSPT
JGPM011003E	10 mm	3/8" BSPT
JGPM011004E	10 mm	1/2" BSPT
JGPM011203E	12 mm	3/8" BSPT
JGPM011204E	12 mm	1/2" BSPT



### EQUAL STRAIGHT CONNECTOR



2110

PART NUMBER	TUBE OD
JGPM0404E	4 mm
JGPM0405E	5 mm
JGPM0406E	6 mm
JGPM0408E	8 mm
JGPM0410E	10 mm
JGPM0412E	12 mm

### EQUAL STRAIGHT CONNECTOR



2110

PART NUMBER	TUBE OD
JGRM0404E	4 mm
JGRM0405E	5 mm
JGRM0408E	8 mm
JGRM0410E	10 mm
JGRM0412E	12 mm



### EQUAL ELBOW



2110

PART NUMBER	TUBE OD
JGPM0304E	4 mm
JGPM0305E	5 mm
JGPM0306E	6 mm
JGPM0308E	8 mm
JGPM0310E	10 mm
JGPM0312E	12 mm

### EQUAL ELBOW



2110

PART NUMBER	TUBE OD
JGRM0304E	4 mm
JGRM0306E	6 mm
JGRM0308E	8 mm
JGRM0310E	10 mm
JGRM0312E	12 mm



EQUAL TEE



2110

PART NUMBER	TUBE OD
JGPM0204E	4 mm
JGPM0205E	5 mm
JGPM0206E	6 mm
JGPM0208E	8 mm
JGPM0210E	10 mm
JGPM0212E	12 mm

EQUAL TEE



2110

PART NUMBER	TUBE OD
JGRM0204E	4 mm
JGRM0208E	8 mm



STEM ADAPTOR  
BSPP MALE



2110

PART NUMBER	STEM OD	THREAD
JGPM050411E	4 mm	1/8" BSPP
JGPM050412E	4 mm	1/4" BSPP
JGPM050511E	5 mm	1/8" BSPP
JGPM050512E	5 mm	1/4" BSPP
JGPM050611E	6 mm	1/8" BSPP
JGPM050612E	6 mm	1/4" BSPP
JGPM050811E	8 mm	1/8" BSPP
JGPM050812E	8 mm	1/4" BSPP
JGPM050813E	8 mm	3/8" BSPP
JGPM051012E	10 mm	1/4" BSPP
JGPM051013E	10 mm	3/8" BSPP
JGPM051014E	10 mm	1/2" BSPP
JGPM051213E	12 mm	3/8" BSPP
JGPM051214E	12 mm	1/2" BSPP



STEM ADAPTOR  
BSPT MALE



2110

PART NUMBER	STEM OD	THREAD
JGPM050401E	4 mm	1/8" BSPT
JGPM050402E	4 mm	1/4" BSPT
JGPM050501E	5 mm	1/8" BSPT
JGPM050502E	5 mm	1/4" BSPT
JGPM050601E	6 mm	1/8" BSPT
JGPM050602E	6 mm	1/4" BSPT
JGPM050801E	8 mm	1/8" BSPT
JGPM050802E	8 mm	1/4" BSPT
JGPM050803E	8 mm	3/8" BSPT
JGPM051002E	10 mm	1/4" BSPT
JGPM051003E	10 mm	3/8" BSPT
JGPM051004E	10 mm	1/2" BSPT
JGPM051203E	12 mm	3/8" BSPT
JGPM051204E	12 mm	1/2" BSPT



FLAT END ADAPTOR  
BSPP FEMALE



2110

PART NUMBER	TUBE OD	THREAD
JGPM450411E*	4 mm	1/8" BSPP
JGPM450611E	6 mm	1/8" BSPP
JGPM450612E*	6 mm	1/4" BSPP
JGPM450812E*	8 mm	1/4" BSPP



REDUCING STRAIGHT  
CONNECTOR



2110

PART NUMBER	TUBE OD	TUBE OD
JGPM200604E	6 mm	4 mm
JGPM200804E	8 mm	4 mm
JGPM200806E	8 mm	6 mm
JGPM201004E	10 mm	4 mm
JGPM201006E	10 mm	6 mm
JGPM201008E	10 mm	8 mm
JGPM201208E	12 mm	8 mm
JGPM201210E	12 mm	10 mm

\* With thread seal, all other sizes no seal



BULKHEAD CONNECTOR



2110

PART NUMBER	TUBE OD
JGPM1204E	4 mm
JGPM1205E	5 mm
JGPM1206E	6 mm
JGPM1208E	8 mm
JGPM1210E	10 mm
JGPM1212E	12 mm

BRASS BULKHEAD ADAPTOR

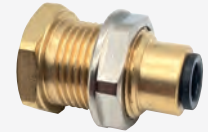

2110

PART NUMBER	TUBE OD
JGRM070612	6 mm
JGRM070812	8 mm

BULKHEAD CONNECTOR



2110

PART NUMBER	TUBE OD
JGRM1206	6 mm



REDUCING ELBOW



2110

PART NUMBER	TUBE OD	TUBE OD
JGPM210604E	6 mm	4 mm
JGPM210804E	8 mm	4 mm
JGPM210806E	8 mm	6 mm
JGPM211004E	10 mm	4 mm
JGPM211006E	10 mm	6 mm
JGPM211008E	10 mm	8 mm
JGPM211208E	12 mm	8 mm
JGPM211210E	12 mm	10 mm



STEM ELBOW



2110

PART NUMBER	TUBE OD	STEM OD
JGPM220404E	4 mm	4 mm
JGPM220505E	5 mm	5 mm
JGPM220606E	6 mm	6 mm
JGPM220808E	8 mm	8 mm
JGPM221010E	10 mm	10 mm
JGPM221212E	12 mm	12 mm



TWO-WAY DIVIDER



2110

PART NUMBER	TUBE OD
JGRM2306E	6 mm
JGRM2308E	8 mm
JGRM2312E	12 mm



TWO-WAY DIVIDER  
COMPACT FITTING



2110

PART NUMBER	TUBE OD
JGPM2304E	4 mm
JGPM2308E	8 mm
JGPM2310E	10 mm



REDUCER



2110

PART NUMBER	TUBE OD	STEM OD
JGPM060504E	4 mm	5 mm
JGPM060604E	4 mm	6 mm
JGPM060605E	5 mm	6 mm
JGPM060804E	4 mm	8 mm
JGPM060805E	5 mm	8 mm
JGPM060806E	6 mm	8 mm
JGPM061006E	6 mm	10 mm
JGPM061008E	8 mm	10 mm
JGPM061208E	8 mm	12 mm
JGPM061210E	10 mm	12 mm



STEM ADAPTOR  
TUBE TO HOSE



2110

PART NUMBER	HOSE ID	STEM OD
JGPM250604E	4 mm	6 mm
JGPM250806E	6 mm	8 mm
JGPM251008E	8 mm	10 mm



PLUG



2110

PART NUMBER	STEM OD
JGPM0804R	4 mm
JGPM0805R	5 mm
JGPM0806R	6 mm
JGPM0808R	8 mm
JGPM0810R	10 mm
JGPM0812R	12 mm



ENLARGER



2110

PART NUMBER	TUBE OD	STEM OD
JGPM130405E	4 mm	5 mm

Literature is available for guidance on installing John Guest fittings, tube & pipe. Please contact your distributor for more details.

## IMPERIAL FITTINGS

Imperial fittings offered in sizes 5/32" to 5/8" are manufactured in grey acetal copolymer, making them especially suitable for applications involving foodstuffs & potable liquids.

They are however equally suitable for air & inert gases & can be used on N<sub>2</sub>/CO<sub>2</sub> (installed in accordance with The British Beer & Pub Association Code of Practice) mixed gas dispense lines & in pneumatic applications & vacuum.



### STRAIGHT ADAPTOR BSPT MALE



2110

PART NUMBER	TUBE OD	THREAD
JGPM010401S	5/32"	1/8" BSPT
JGPI010601S	3/16"	1/8" BSPT
JGPI010801S	1/4"	1/8" BSPT
JGPI010802S	1/4"	1/4" BSPT
JGPM010801S	5/16"	1/8" BSPT
JGPM010802S	5/16"	1/4" BSPT
JGPM010803S	5/16"	3/8" BSPT
JGPI011202S	3/8"	1/4" BSPT
JGPI011203S	3/8"	3/8" BSPT
JGPI011603S	1/2"	3/8" BSPT
JGPI011604S	1/2"	1/2" BSPT



### STRAIGHT ADAPTOR BSPP MALE



2110

PART NUMBER	TUBE OD	THREAD
JGPI010812S	1/4"	1/4" BSPP
JGPI011212S	3/8"	1/4" BSPP



### STRAIGHT ADAPTOR NPTF MALE



2110

PART NUMBER	TUBE OD	THREAD
JGPM010421S	5/32"	1/8" NPTF
JGPM010422S	5/32"	1/4" NPTF
JGPI010621S	3/16"	1/8" NPTF
JGPI010821S	1/4"	1/8" NPTF
JGPI010822S	1/4"	1/4" NPTF
JGPI010823S	1/4"	3/8" NPTF
JGPM010821S	5/16"	1/8" NPTF
JGPM010822S	5/16"	1/4" NPTF
JGPM010823S	5/16"	3/8" NPTF
JGPI011221S	3/8"	1/8" NPTF
JGPI011222S	3/8"	1/4" NPTF
JGPI011223S	3/8"	3/8" NPTF
JGPI011224S	3/8"	1/2" NPTF
JGPI011623S	1/2"	3/8" NPTF
JGPI011624S	1/2"	1/2" NPTF
JGPI012026S	5/8"	3/4" NPTF



### EQUAL STRAIGHT ADAPTOR



2110

PART NUMBER	TUBE OD
JGPM0404S	5/32"
JGPI0406S	3/16"
JGPI0408S	1/4"
JGPM0408S	5/16"
JGPI0412S	3/8"
JGPI0416S	1/2"



### REDUCING STRAIGHT ADAPTOR



2110

PART NUMBER	TUBE OD	TUBE OD
JGPI200806S	1/4"	3/16"
JGPM200804S	5/16"	5/32"
JGPI201006S	5/16"	3/16"
JGPI201008S	5/16"	1/4"
JGPI201206S	3/8"	3/16"
JGPI201208S	3/8"	1/4"
JGPI201210S	3/8"	5/16"
JGPI201610S	1/2"	5/16"
JGPI201612S	1/2"	3/8"



### EQUAL TEE



2110

PART NUMBER	TUBE OD
JGPM0204S	5/32"
JGPI0206S	3/16"
JGPI0208S	1/4"
JGPM0208S	5/16"
JGPI0212S	3/8"
JGPI0216S	1/2"



### REDUCING TEE

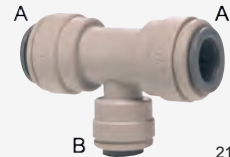

2110

PART NUMBER	TUBE OD (A)	TUBE OD (B)
JGPI301208S	3/8"	1/4"
JGPI301612S	1/2"	3/8"



EQUAL ELBOW



2110

PART NUMBER	TUBE OD
JGPM0304S	5/32"
JGPI0306S	3/16"
JGPI0308S	1/4"
JGPM0308S	5/16"
JGPI0312S	3/8"
JGPI0316S	1/2"



STEM ADAPTOR  
BSPT MALE



2110

PART NUMBER	STEM OD	THREAD
JGPI050601S	3/16"	1/8" BSPT
JGPI050801S	1/4"	1/8" BSPT
JGPI050802S	1/4"	1/4" BSPT
JGPM050801S	5/16"	1/8" BSPT
JGPM050802S	5/16"	1/4" BSPT
JGPM050803S	5/16"	3/8" BSPT
JGPI051202S	3/8"	1/4" BSPT
JGPI051203S	3/8"	3/8" BSPT
JGPI051603S	1/2"	3/8" BSPT
JGPI051604S	1/2"	1/2" BSPT



FLAT END ADAPTOR  
BSPP FEMALE



2110

PART NUMBER	TUBE OD	THREAD
JGPI451213S	3/8"	3/8" BSPP
JGPI451613S	1/2"	3/8" BSPP



STEM ELBOW



2110

PART NUMBER	TUBE OD	STEM OD
JGPM220404S	5/32"	5/32"
JGPI220606S	3/16"	3/16"
JGPI220808S	1/4"	1/4"
JGPM220808S	5/16"	5/16"
JGPI221212S	3/8"	3/8"
JGPI221616S	1/2"	1/2"



PLUG



2110

PART NUMBER	STEM OD
JGPM0804S	5/32"
JGPI0806S	3/16"
JGPI0808S	1/4"
JGPM0808S	5/16"
JGPI0812S	3/8"
JGPI0816S	1/2"



BULKHEAD CONNECTOR



2110

PART NUMBER	TUBE OD
JGPM1204S	5/32"
JGPI1206S	3/16"
JGPI1208S	1/4"
JGPM1208S	5/16"
JGPI1212S	3/8"
JGPI1216S	1/2"



STEM ADAPTOR  
TUBE TO HOSE



2110

PART NUMBER	STEM OD	HOSE ID
JGPI250806S	1/4"	3/16"
JGPI250808S	1/4"	1/4"
JGPI250810S	1/4"	5/16"
JGPI251006S	5/16"	3/16"
JGPI251008S	5/16"	1/4"
JGPM250808S	5/16"	5/16"
JGPI251012S	5/16"	3/8"
JGPI251208S	3/8"	1/4"
JGPI251210S	3/8"	5/16"
JGPI251212S	3/8"	3/8"
JGPI251216S	3/8"	1/2"
JGPI251612S	1/2"	3/8"
JGPI251616S	1/2"	1/2"

TUBE INSERT



2110

PART NUMBER	TUBE ID
JGTSI250S	1/4"
JGTSI312S	5/16"
JGTSI375S	3/8"



ELBOW  
TUBE TO HOSE



2110

PART NUMBER	HOSE ID	STEM OD
JGPI290808S	1/4"	1/4"
JGPI290810S	5/16"	1/4"
JGPI291008S	1/4"	5/16"
JGPM290808S	5/16"	5/16"
JGPI291208S	1/4"	3/8"
JGPI291210S	5/16"	3/8"



3-WAY DIVIDER



2110

PART NUMBER	TUBE OD INLET	TUBE OD OUTLET
JGPI491612S	1/2"	3/8"

### SPECIFICATIONS

Temperature range	-15°C to +225°C
Minimum pressure	-0.99 bar
Maximum pressure	15 bar
<b>MATERIALS</b>	
Body, collet, capsule & clamping washer	316L stainless steel
Safety ring	Teflon™
Lip seal & thread packing	Food FKM

### THREAD DETAILS

Tapered gas in conformity with ISO 7.1, BS 21, DIN 2999
Parallel gas in conformity with ISO 228 Class A
Metric in conformity with ISO R/262

### STRAIGHT ADAPTOR BSPT MALE



1480

PART NUMBER	TUBE OD	THREAD
A6000-0418	4 mm	1/8" BSPT
A6000-0414	4 mm	1/4" BSPT
A6000-0618	6 mm	1/8" BSPT
A6000-0614	6 mm	1/4" BSPT
A6000-0818	8 mm	1/8" BSPT
A6000-0814	8 mm	1/4" BSPT
A6000-1014	10 mm	1/4" BSPT
A6000-1038	10 mm	3/8" BSPT
A6000-1238	12 mm	3/8" BSPT
A6000-1212	12 mm	1/2" BSPT

### STRAIGHT ADAPTOR METRIC MALE



1480

PART NUMBER	TUBE OD	THREAD
A6020-04M5	4 mm	M5

### BSPP MALE

PART NUMBER	TUBE OD	THREAD
A6020-0418	4 mm	1/8" BSPP
A6020-0414	4 mm	1/4" BSPP
A6020-0618	6 mm	1/8" BSPP
A6020-0614	6 mm	1/4" BSPP
A6020-0818	8 mm	1/8" BSPP
A6020-0814	8 mm	1/4" BSPP
A6020-1014	10 mm	1/4" BSPP
A6020-1038	10 mm	3/8" BSPP
A6020-1238	12 mm	3/8" BSPP
A6020-1212	12 mm	1/2" BSPP

### STRAIGHT CONNECTOR



1480

PART NUMBER	TUBE OD
A6040-04	4 mm
A6040-06	6 mm
A6040-08	8 mm
A6040-10	10 mm
A6040-12	12 mm

### BULKHEAD CONNECTOR METRIC MALE



1480

PART NUMBER	TUBE OD	THREAD
A6050-04M12	4 mm	M12 x 1
A6050-06M14	6 mm	M14 x 1
A6050-08M16	8 mm	M16 x 1
A6050-10M20	10 mm	M20 x 1
A6050-12M22	12 mm	M22 x 1

### SWIVEL ELBOW ADAPTOR BSPT MALE



1480

PART NUMBER	TUBE OD	THREAD
A6110-0418	4 mm	1/8" BSPT
A6110-0414	4 mm	1/4" BSPT
A6110-0618	6 mm	1/8" BSPT
A6110-0614	6 mm	1/4" BSPT
A6110-0818	8 mm	1/8" BSPT
A6110-0814	8 mm	1/4" BSPT
A6110-1014	10 mm	1/4" BSPT
A6110-1038	10 mm	3/8" BSPT
A6110-1012	10 mm	1/2" BSPT
A6110-1238	12 mm	3/8" BSPT
A6110-1212	12 mm	1/2" BSPT

### SWIVEL ELBOW ADAPTOR METRIC MALE



1480

PART NUMBER	TUBE OD	THREAD
A6115-04M5	4 mm	M5

### BSPP MALE

PART NUMBER	TUBE OD	THREAD
A6115-0418	4 mm	1/8" BSPP
A6115-0414	4 mm	1/4" BSPP
A6115-0618	6 mm	1/8" BSPP
A6115-0614	6 mm	1/4" BSPP
A6115-0818	8 mm	1/8" BSPP
A6115-0814	8 mm	1/4" BSPP
A6115-1014	10 mm	1/4" BSPP
A6115-1038	10 mm	3/8" BSPP
A6115-1012	10 mm	1/2" BSPP
A6115-1238	12 mm	3/8" BSPP
A6115-1212	12 mm	1/2" BSPP





ELBOW CONNECTOR

1480

PART NUMBER	TUBE OD
A6130-04	4 mm
A6130-06	6 mm
A6130-08	8 mm
A6130-10	10 mm
A6130-12	12 mm



TEE CONNECTOR

1480

PART NUMBER	TUBE OD
A6230-04	4 mm
A6230-06	6 mm
A6230-08	8 mm
A6230-10	10 mm
A6230-12	12 mm



SWIVEL TEE ADAPTOR  
CENTRE LEG  
BSPT MALE

1480

PART NUMBER	TUBE OD	THREAD
A6210-0418	4 mm	1/8" BSPT
A6210-0414	4 mm	1/4" BSPT
A6210-0618	6 mm	1/8" BSPT
A6210-0614	6 mm	1/4" BSPT
A6210-0818	8 mm	1/8" BSPT
A6210-0814	8 mm	1/4" BSPT
A6210-1014	10 mm	1/4" BSPT
A6210-1038	10 mm	3/8" BSPT
A6210-1012	10 mm	1/2" BSPT
A6210-1238	12 mm	3/8" BSPT
A6210-1212	12 mm	1/2" BSPT



SWIVEL TEE ADAPTOR  
CENTRE LEG  
METRIC MALE

1480

PART NUMBER	TUBE OD	THREAD
A6215-04M5	4 mm	M5

BSPP MALE

PART NUMBER	TUBE OD	THREAD
A6215-0418	4 mm	1/8" BSPP
A6215-0414	4 mm	1/4" BSPP
A6215-0618	6 mm	1/8" BSPP
A6215-0614	6 mm	1/4" BSPP
A6215-0818	8 mm	1/8" BSPP
A6215-0814	8 mm	1/4" BSPP
A6215-1014	10 mm	1/4" BSPP
A6215-1038	10 mm	3/8" BSPP
A6215-1012	10 mm	1/2" BSPP
A6215-1238	12 mm	3/8" BSPP
A6215-1212	12 mm	1/2" BSPP

Do you also need?

**PARKAIR®**

**PTFE tube**



Find it on page 670, section ten

### DESCRIPTION

316L stainless steel push-in fittings (metric tube, BSPT / BSPP / FKM seals). Manufactured to ISO9001:2008, RoHS, CE. Withstands corrosive environments to aggressive fluid, can be used with food, medical & chemical applications & extreme hot or cold conditions.

### SPECIFICATIONS

Medium	Air, water, oil
Working pressure	0 – 217 psi (0 – 15 bar)
Vacuum rating	to 28" Hg
Working temperature	-15°C to +220°C
Applicable tubings	PTFE, FEP, PU, PE, PA, PVDF

### MATERIALS

Body	316L stainless steel
Release sleeve	316L stainless steel
Collar / lock claw	316L stainless steel
V-seals / O-rings	FKM

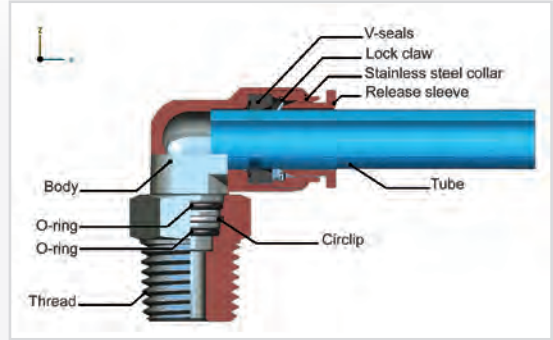

**COUPLING  
BSPP FEMALE**

1745

PART NUMBER	TUBE OD	THREAD
SSPCF6-01	6 mm	1/8" BSPP
SSPCF6-02	6 mm	1/4" BSPP
SSPCF8-02	8 mm	1/4" BSPP
SSPCF8-03	8 mm	3/8" BSPP
SSPCF10-02	10 mm	1/4" BSPP



New Additions

**ELBOW  
BSPT MALE**

1745

PART NUMBER	TUBE OD	THREAD
SSPL4-01	4 mm	1/8" BSPT
SSPL6-01	6 mm	1/8" BSPT
SSPL6-02	6 mm	1/4" BSPT
SSPL8-02	8 mm	1/4" BSPT
SSPL8-03	8 mm	3/8" BSPT
SSPL10-02	10 mm	1/4" BSPT



New Additions

**COUPLING  
BSPT MALE**

1745

PART NUMBER	TUBE OD	THREAD
SSPC4-01	4 mm	1/8" BSPT
SSPC6-01	6 mm	1/8" BSPT
SSPC6-02	6 mm	1/4" BSPT
SSPC8-02	8 mm	1/4" BSPT
SSPC8-03	8 mm	3/8" BSPT
SSPC10-02	10 mm	1/4" BSPT
SSPC10-03	10 mm	3/8" BSPT



New Additions

**EQUAL ELBOW**

1745

PART NUMBER	TUBE OD
SSPUL4	4 mm
SSPUL6	6 mm
SSPUL8	8 mm
SSPUL10	10 mm



New Additions

**EQUAL STRAIGHT**

1745

PART NUMBER	TUBE OD
SSPUC4	4 mm
SSPUC6	6 mm
SSPUC8	8 mm
SSPUC10	10 mm



**EQUAL TEE**

1745

PART NUMBER	TUBE OD
SSPUT6	6 mm
SSPUT8	8 mm
SSPUT10	10 mm